



F5 PRODUCT GUIDE



TABLE OF CONTENTS

Application Services	3
Traffic Management	4
Local Traffic Manager	4
Better and Best Bundles	10
DNS Delivery	14
Policy Enforcement Manager	17
Virtualised Network Function Bundles	20
Hardware Options	21
Application Security	22
Advanced Web Application Firewall	22
DataSafe	25
Threat Campaigns	26
Anti-Bot Mobile SDK	27
Application Security Manager	28
IP Intelligence Services	30
Intrusion Prevention System	31
Web Fraud Protection	33
Managed Web Application Firewall Services	35
Managed Threat Intelligence Services	35
Application Access	36
Access Policy Manager	36
Secure Web Gateway	39
URL Filtering	40
Infrastructure Security	41
SSL Orchestrator	41
Advanced Firewall Manager	43
Carrier Grade NAT	45
DDoS Hybrid Defender	47
Managed DDoS Protection Services	48
Automation, Orchestration, and Management	49
Automation Toolchain	49
Technologies and Programmability	49
Container Ingress Services	49
Centralised Management	50
Global Services	52
Support Services	52
Professional Services	54
Training Services	56

APPLICATION SERVICES

Application services and protection for every app, anywhere

The F5 portfolio of enterprise-grade application services ensures that apps are fast, available, and secure – across any on-premises or multi-cloud environment.

F5 has the advanced application services you need to:

- Develop and deploy applications in the cloud
- Build new apps and migrate existing apps to the cloud
- Be more agile without sacrificing quality or security
- Overcome inefficient IT operations and scarce developer resources
- Ensure apps are fast and always-on, for better end-user experience

F5 application services integrate with major cloud providers and are available directly through marketplace offerings with variable PAYG or perpetual BYOL consumption options.

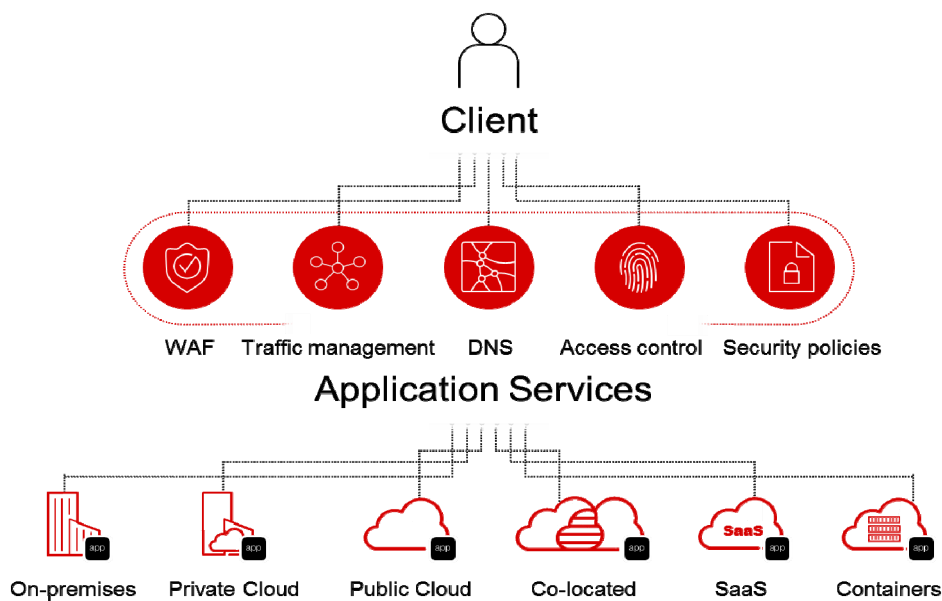

Deploy however you want:

- **Cloud** – F5 application services work the same way in the public and private cloud as they do in the data center
- **Virtual Editions** – VEs have the same features as those that run on F5 hardware and can be deployed on any hypervisor or select cloud provider
- **Hardware** – Both the BIG-IP family of devices and the VIPRION chassis are purpose-built, powerful hardware that F5 software runs on

F5 Networks gives the world's largest businesses, service providers, governments, and consumer brands the freedom to securely deliver every app, anywhere – with confidence. F5 delivers cloud and security application services that enable organisations to embrace the infrastructure they choose without sacrificing speed and control. For more information, go to [f5.com](https://www.f5.com).

TRAFFIC MANAGEMENT

LOCAL TRAFFIC MANAGER

Intelligent application traffic management

BIG-IP Local Traffic Manager (LTM) enables you to control network traffic, selecting the right destination based on server performance, security, and availability. BIG-IP LTM helps deliver applications to users in a reliable, secure, and optimised way. You get the extensibility and flexibility of application services with programmability to manage physical, virtual, and cloud infrastructure.

Key benefits

- Deliver applications rapidly and reliably
- Automate and customise with programmable infrastructure
- Transition to SDN and cloud networks
- Easily deploy and manage applications
- Secure your critical applications



BIG-IP iSeries Appliances



VIPRION Chassis



BIG-IP Virtual Editions

BIG-IP Cloud Edition Local Traffic Manager (LTM)

Dedicated per-app services

BIG-IP Cloud Edition supports app teams' need for flexibility and speed, while enabling operations teams to standardise on consistent network and security policies. Cloud Edition is composed of tightly integrated BIG-IQ Centralized Management and BIG-IP Per-App Virtual Editions to deliver advanced app services and lifecycle management, including autoscale, self-service management for app owners, and per-app analytics.

Key benefits

- Dedicated per-app services
- Self-service management
- On-demand autoscale
- Faster troubleshooting
- Flexible licensing

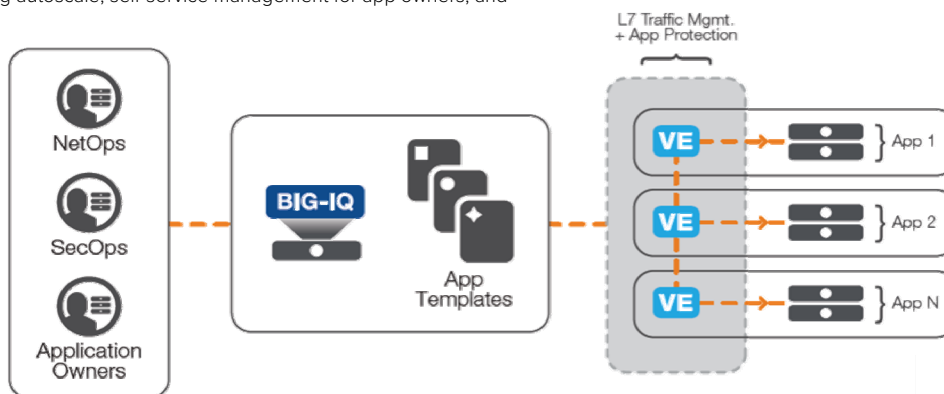

Description	Part Number
BIG-IP Cloud Edition Local Traffic Manager 200 Mbps (per app, v13.1 - v18.x)	F5-BIG-LTM-PVE200MV18
BIG-IP Cloud Edition Local Traffic Manager 25 Mbps (per app, v13.1 - v18.x)	F5-BIG-LTM-PVE25MV18
BIG-IP Cloud Edition Local Traffic Manager Pool 200 Mbps (per app, 20 instances, v13.1 - v18.x)	F5-BIGLTMPEP200MV18
BIG-IP Cloud Edition Local Traffic Manager Pool 25 Mbps (per app, 20 instances, v13.1 - v18.x)	F5-BIG-LTMPVEP25MV18
BIG-IP Cloud Edition Local Traffic Manager Add-on License Pool 200 Mbps (per app, 10 instances)	F5-ADDBIGLTMPEP200M
BIG-IP Cloud Edition Local Traffic Manager Add-on License Pool 25 Mbps (per app, 10 instances)	F5-ADD-BIGLTMPEP25M
BIG-IP Cloud Edition Service Scaling (8 vCPUs, v13.x - v18.x)	F5-BIG-SVS-VE-08-V18

BIG-IP Virtual Edition Local Traffic Manager (LTM)

F5 application services in any environment

BIG-IP Virtual Editions deliver the application services you need, in an agile form factor. Get the scalability, security, customisation, and adaptability BIG-IP products are known for – all in software designed for virtual, cloud, and hybrid environments. Virtual Editions of BIG-IP products offer the same breadth of features available in hardware solutions.

Key benefits

- Deploy with increased agility
- Achieve automation and orchestration in cloud architectures
- Optimise application and security services
- Provide the ultimate in flexibility

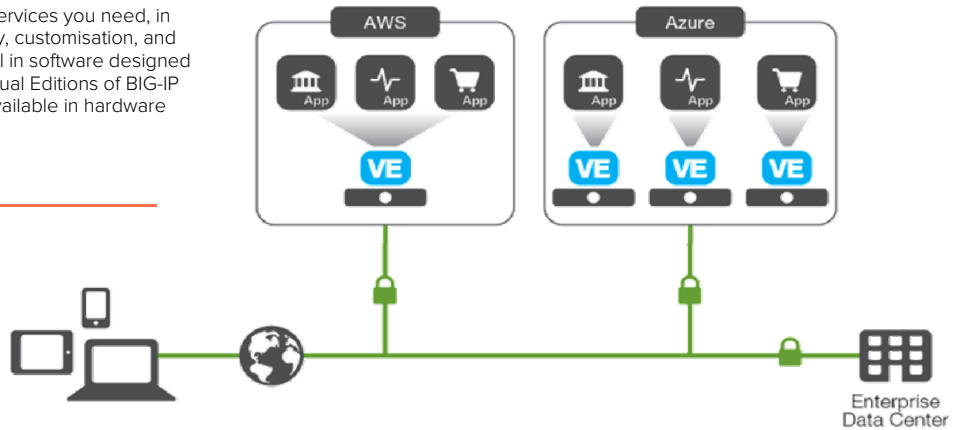

Subscription Licenses: Get the application services you need with lower upfront cost.

Enterprise License Agreement: Deploy what you want, when you want, where you want, with BIG-IP Virtual Editions.

Description	Part Number
BIG-IP Virtual Edition Local Traffic Manager High Performance (24 vCPUs, v13.1.x - v18.x)	F5-BIG-LTM-VE-24-V18
BIG-IP Virtual Edition Local Traffic Manager High Performance (16 vCPUs, v13.x - v18.x)	F5-BIG-LTM-VE-16-V18
BIG-IP Virtual Edition Local Traffic Manager High Performance (8 vCPUs, v13.x - v18.x)	F5-BIG-LTM-VE-08-V18
BIG-IP Virtual Edition Local Traffic Manager 10 Gbps (v12.1.x - v18.x)	F5-BIG-LTM-VE-10GV18
BIG-IP Virtual Edition Local Traffic Manager 5 Gbps (v12.1.x - v18.x)	F5-BIG-LTM-VE-5G-V18
BIG-IP Virtual Edition Local Traffic Manager 3 Gbps (v12.1.x - v18.x)	F5-BIG-LTM-VE-3G-V18
BIG-IP Virtual Edition Local Traffic Manager 1 Gbps (v12.1.x - v18.x)	F5-BIG-LTM-VE-1G-V18
BIG-IP Virtual Edition Local Traffic Manager 200 Mbps (v12.1.x - v18.x)	F5-BIG-LTM-VE200MV18
BIG-IP Virtual Edition Local Traffic Manager 25 Mbps (v12.1.x - v18.x)	F5-BIG-LTM-VE-25MV18
BIG-IP Virtual Edition Lab License (10 Mbps, v12.1.x - v18.x)	F5-BIG-VE-LAB-V18
BIG-IP Virtual Edition Lab License for Service Providers (10 Mbps, v12.1.x - v18.x)	F5-BIG-VE-LAB-SP-V18

Local Traffic Manager (LTM) Add-on Licenses for BIG-IP Virtual Edition

Description	Part Number
BIG-IP Virtual Edition Local Traffic Manager Add-on License High Performance (4 vCPUs)	F5-ADD-BIG-LTM-VE-04
BIG-IP Virtual Edition Local Traffic Manager Add-on License 10 Gbps	F5-ADD-BIG-LTM-VE10G
BIG-IP Virtual Edition Local Traffic Manager Add-on License 5 Gbps	F5-ADD-BIG-LTM-VE5G
BIG-IP Virtual Edition Local Traffic Manager Add-on License 3 Gbps	F5-ADD-BIG-LTM-VE3G
BIG-IP Virtual Edition Local Traffic Manager Add-on License 1 Gbps	F5-ADD-BIG-LTM-VE1G
BIG-IP Virtual Edition Local Traffic Manager Add-on License 200 Mbps	F5-ADD-BIG-LTMVE200M
BIG-IP Virtual Edition Local Traffic Manager Add-on License 25 Mbps	F5-ADD-BIG-LTM-VE25M

License Upgrades for BIG-IP Virtual Edition

Description	Part Number
BIG-IP Virtual Edition License Upgrade (5 Gbps to 10 Gbps)	F5-ADD-BIG-VE-UP-10G
BIG-IP Virtual Edition License Upgrade (3 Gbps to 5 Gbps)	F5-ADD-BIG-VE-UP-5G
BIG-IP Virtual Edition License Upgrade (1 Gbps to 3 Gbps)	F5-ADD-BIG-VE-UP-3G
BIG-IP Virtual Edition License Upgrade (200 Mbps to 1 Gbps)	F5-ADD-BIG-VE-UP-1G
BIG-IP Virtual Edition License Upgrade (25 Mbps to 200 Mbps)	F5-ADD-BIG-VE-UP200M

Add-on Licenses for BIG-IP Virtual Edition

Description	Part Number
BIG-IP Virtual Edition Advanced Routing License (RIP, OSPF, BGP, IS-IS, BFD)	F5-ADD-BIGVE-ROUTING
BIG-IP Virtual Edition Multicast Routing License	F5-ADDBIGVEMULTICAST
BIG-IP Virtual Edition Advanced Protocols License	F5-ADDBIGADVPROCS-VE

BIG-IP iSeries Local Traffic Manager (LTM)

Gain agility with the most programmable cloud-ready ADC

F5's cloud-ready Application Delivery Controller (ADC) platform provides DevOps-like agility with the scale, security depth, and investment protection needed for both established and emerging apps. BIG-IP iSeries appliances deliver application services with quick and easy programmability, multi-vendor service orchestration, software-defined hardware, and line-rate performance.



Key benefits

- Reduce deployment time
- Improve development time
- Consolidate application services
- Simplify and scale SSL
- Protect critical data
- Secure applications
- Maximise uptime
- Maximise investment protection

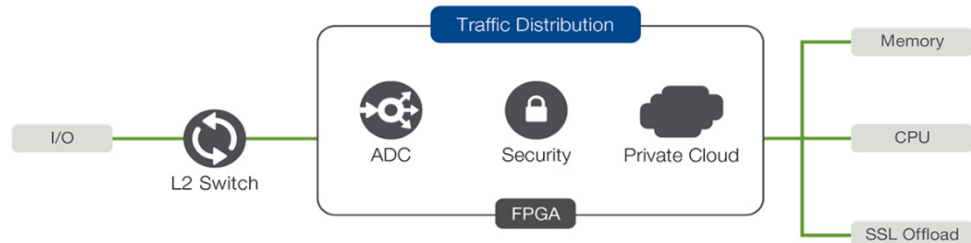

Description	Part Number
BIG-IP i15800 Local Traffic Manager (512 GB Memory, SSD, Max SSL, Max Compression, vCMP, Dual AC Power Supplies)	F5-BIG-LTM-i15800
BIG-IP i11800 Local Traffic Manager Turbo SSL (256 GB Memory, Dual SSD, Max SSL, Max Compression, vCMP, Dual AC Power Supplies)	F5-BIG-LTM-i11800-DS
BIG-IP i11800 Local Traffic Manager (256 GB Memory, SSD, Max SSL, Max Compression, vCMP, Dual AC Power Supplies)	F5-BIG-LTM-i11800
BIG-IP i10800 Local Traffic Manager (128 GB Memory, Dual SSD, Max SSL, Max Compression, vCMP, Dual AC Power Supplies)	F5-BIG-LTM-i10800-D
BIG-IP i10800 Local Traffic Manager (128 GB Memory, SSD, Max SSL, Max Compression, vCMP, Dual AC Power Supplies)	F5-BIG-LTM-i10800
BIG-IP i7800 Local Traffic Manager (96 GB Memory, Dual SSD, Max SSL, Max Compression, vCMP, Dual AC Power Supplies)	F5-BIG-LTM-i7800-D
BIG-IP i7800 Local Traffic Manager (96 GB Memory, SSD, Max SSL, Max Compression, vCMP, Dual AC Power Supplies)	F5-BIG-LTM-i7800
BIG-IP i5800 Local Traffic Manager (48 GB Memory, SSD, Max SSL, Max Compression, vCMP)	F5-BIG-LTM-i5800
BIG-IP i4800 Local Traffic Manager (32 GB Memory, Max SSL, Max Compression)	F5-BIG-LTM-i4800
BIG-IP i2800 Local Traffic Manager (16 GB Memory, Max SSL, Max Compression)	F5-BIG-LTM-i2800
BIG-IP i15600 Local Traffic Manager (512 GB Memory, SSD, Base SSL, Base Compression, Dual AC Power Supplies)	F5-BIG-LTM-i15600
BIG-IP i11600 Local Traffic Manager Turbo SSL (256 GB Memory, Dual SSD, Base SSL, Base Compression, vCMP, Dual AC Power Supplies)	F5-BIG-LTM-i11600-DS
BIG-IP i11600 Local Traffic Manager (256 GB Memory, SSD, Base SSL, Base Compression, Dual AC Power Supplies)	F5-BIG-LTM-i11600
BIG-IP i11400 Local Traffic Manager Turbo SSL (256 GB Memory, Dual SSD, Base SSL, Base Compression, vCMP, Dual AC Power Supplies)	F5-BIG-LTM-i11400-DS
BIG-IP i10600 Local Traffic Manager (128 GB Memory, Dual SSD, Base SSL, Base Compression, Dual AC Power Supplies)	F5-BIG-LTM-i10600-D
BIG-IP i10600 Local Traffic Manager (128 GB Memory, SSD, Base SSL, Base Compression, Dual AC Power Supplies)	F5-BIG-LTM-i10600
BIG-IP i7600 Local Traffic Manager (96 GB Memory, Dual SSD, Base SSL, Base Compression, Dual AC Power Supplies)	F5-BIG-LTM-i7600-D
BIG-IP i7600 Local Traffic Manager (96 GB Memory, SSD, Base SSL, Base Compression, Dual AC Power Supplies)	F5-BIG-LTM-i7600
BIG-IP i5600 Local Traffic Manager (48 GB Memory, SSD, Base SSL, Base Compression)	F5-BIG-LTM-i5600
BIG-IP i4600 Local Traffic Manager (32 GB Memory, Base SSL, Base Compression)	F5-BIG-LTM-i4600
BIG-IP i2600 Local Traffic Manager (16 GB Memory, Base SSL, Base Compression)	F5-BIG-LTM-i2600
BIG-IP i7820 Local Traffic Manager FIPS (96 GB Memory, Dual SSD, Hardware Security Module, Max SSL, Max Compression, vCMP, Dual AC Power Supplies)	F5-BIG-LTM-i7820-DF
BIG-IP i5820 Local Traffic Manager FIPS (48 GB Memory, Dual SSD, Hardware Security Module, Max SSL, Max Compression, vCMP)	F5-BIG-LTM-i5820-DF
BIG-IP 10350v Local Traffic Manager FIPS (128 GB Memory, SSD, Hardware Security Module, Max SSL, Max Compression, Dual AC Power Supplies)	F5-BIG-LTM-10350V-F
BIG-IP i15800 Local Traffic Manager NEBS (512 GB Memory, SSD, Max SSL, Max Compression, vCMP, Dual DC Power Supplies, NEBS Level 3 Certified)	F5-BIG-LTM-i15800-N
BIG-IP i15600 Local Traffic Manager NEBS (512 GB Memory, SSD, Base SSL, Base Compression, Dual DC Power Supplies only, NEBS Level 3 Certified)	F5-BIG-LTM-i15600-N
BIG-IP 10350v Local Traffic Manager NEBS (128 GB Memory, SSD, Max SSL, Max Compression, vCMP, Dual DC Power Supplies only, NEBS Level 3 Certified)	F5-BIG-LTM-10350V-N
BIG-IP 10150s Local Traffic Manager NEBS (128 GB Memory, SSD, Max SSL, Max Compression, Dual DC Power Supplies only, NEBS Level 3 Certified)	F5-BIG-LTM-10150S-N

Local Traffic Manager (LTM) Add-on Modules for BIG-IP iSeries

Description	Part Number
BIG-IP Local Traffic Manager Module for i15X00	F5-ADD-BIG-LTMi15XXX
BIG-IP Local Traffic Manager Module for i11X00	F5-ADD-BIG-LTMi11XXX
BIG-IP Local Traffic Manager Module for i10X00	F5-ADD-BIG-LTMi10XXX
BIG-IP Local Traffic Manager Module for i7X00	F5-ADD-BIG-LTM-i7XXX
BIG-IP Local Traffic Manager Module for i5X00	F5-ADD-BIG-LTM-i5XXX
BIG-IP Local Traffic Manager Module for i4X00	F5-ADD-BIG-LTM-i4XXX
BIG-IP Local Traffic Manager Module for i2X00	F5-ADD-BIG-LTM-i2XXX
BIG-IP Local Traffic Manager Module for 10X5Xs	F5-ADD-BIG-LTM-10000

License Upgrades for BIG-IP iSeries

Description	Part Number
BIG-IP i15600 to i15800 License Upgrade	F5-ADD-BIG-I158XX
BIG-IP i11600 to i11800 License Upgrade	F5-ADD-BIG-i118XX
BIG-IP i10600 to i10800 License Upgrade	F5-ADD-BIG-I108XX
BIG-IP i7600 to i7800 License Upgrade	F5-ADD-BIG-I78XX
BIG-IP i5600 to i5800 License Upgrade	F5-ADD-BIG-I58XX
BIG-IP i4600 to i4800 License Upgrade	F5-ADD-BIG-I48XX
BIG-IP i2600 to i2800 License Upgrade	F5-ADD-BIG-I28XX
BIG-IP i11600 Dual SSD to i11800 Dual SSD License Upgrade	F5-ADD-BIG-i118XXDS2
BIG-IP i11400 Dual SSD to i11800 Dual SSD License Upgrade	F5-ADD-BIG-i118XXDS1
BIG-IP i11400 Dual SSD to i11600 Dual SSD License Upgrade	F5-ADD-BIG-I116XX-DS
BIG-IP 10150s to 10350v License Upgrade	F5-ADD-BIG-10350V

Add-on Modules for BIG-IP iSeries

Description	Part Number
BIG-IP Advanced Routing Modules Pack (RIP, OSPF, BGP, IS-IS, BFD)	F5-ADD-BIG-ROUTING
BIG-IP Multicast Routing Module	F5-ADD-BIG-MULTICAST
BIG-IP Software Defined Networking Services License	F5-ADD-BIG-SDN
BIG-IP Advanced Protocols License	F5-ADD-BIG-ADV-PROCS

VIPRION Local Traffic Manager (LTM)

The highest performing application delivery controller in the world

The VIPRION platform delivers quick and easy programmability, multi-vendor service orchestration, software-defined hardware, and line-rate performance. VIPRION empowers you to dynamically scale and adapt – add blades without disrupting your apps or users, extending superior power without adding devices.

Key benefits

- Reduce deployment time
- Improve development time
- Consolidate application services
- Simplify and scale SSL
- Maximise performance
- Achieve ultimate reliability



Description	Part Number
VIPRION 4800 Local Traffic Manager Chassis (8 x Slots, 2 x AC Power Supplies)	F5-VPR-LTM-C4800-AC
VIPRION 4480 Local Traffic Manager Chassis (4 x Slots, 4 x AC Power Supplies)	F5-VPR-LTM-C4480-AC
VIPRION 4800 Local Traffic Manager Chassis NEBS (8 x Slots, 2 x DC Power Supplies, NEBS Level 3 Certified)	F5-VPR-LTM-C4800-DCN
VIPRION 4480 Local Traffic Manager Chassis NEBS (4 x Slots, 4 x DC Power Supplies, NEBS Level 3 Certified)	F5-VPR-LTM-C4480-DCN
VIPRION 4450 Local Traffic Manager Blade NEBS (256 GB Memory, 6 x QSFP+ Ports, 2 x QSFP28 Ports, NEBS Level 3 Certified)	F5-VPR-LTM-B4450N
VIPRION 2400 Local Traffic Manager Chassis (4 x Slots, 2 x AC Power Supplies)	F5-VPR-LTM-C2400-AC
VIPRION 2200 Local Traffic Manager Chassis (2 x Slots, 2 x AC Power Supplies)	F5-VPR-LTM-C2200-AC
VIPRION 2200 Local Traffic Manager Chassis (2 x Slots, 2 x DC Power Supplies)	F5-VPR-LTM-C2200-DC
VIPRION 2250 Blade (64 GB Memory, SSD, 4 x QSFP+ Ports)	F5-VPR-LTM-B2250
VIPRION 2150 Blade (32 GB Memory, SSD, 8 x SFP+ Ports with 2 x 10GBASE-SR Transceivers included)	F5-VPR-LTM-B2150

Local Traffic Manager (LTM) Add-on Modules for VIPRION

Description	Part Number
VIPRION Local Traffic Manager Module for 4800 Chassis	F5-ADD-VPR-LTM-C4800
VIPRION Local Traffic Manager Module for 4480 Chassis	F5-ADD-VPR-LTM-C4400
VIPRION Local Traffic Manager Module for 2X00 Chassis	F5-ADD-VPR-LTM-C2400

Add-on Licenses for VIPRION

Description	Part Number
VIPRION Virtual Clustered Multiprocessing License for 4800 Chassis	F5-ADD-VPR-VCMP-4800
VIPRION Virtual Clustered Multiprocessing License for 4480 Chassis	F5-ADD-VPR-VCMP-4480
VIPRION Virtual Clustered Multiprocessing License for 2400 Chassis	F5-ADD-VPR-VCMP-2400
VIPRION Virtual Clustered Multiprocessing License for 2200 Chassis	F5-ADD-VPR-VCMP-2200
VIPRION Compression License Upgrade for 4800 Chassis (Max Gbps)	F5-ADD-VPR-CMP8
VIPRION Compression License Upgrade for 4480/2400 Chassis (Max Gbps)	F5-ADD-VPR-CMP4
VIPRION Compression License Upgrade for 2200 Chassis (Max Gbps)	F5-ADD-VPR-CMP2
VIPRION Software Defined Networking Services License	F5-ADD-VPR-SDN
VIPRION Advanced Protocols License	F5-ADD-VPR-ADV-PROCS

NGINX Plus

High-performance application delivery for microservices

NGINX Plus is a software load balancer, web server, and content cache built on top of open source NGINX. NGINX Plus has exclusive enterprise-grade features beyond what's available in the open source offering, including session persistence, configuration via API, and active health checks.

Key benefits

- Cost effective
- Flexible and portable
- Automated
- Consolidated

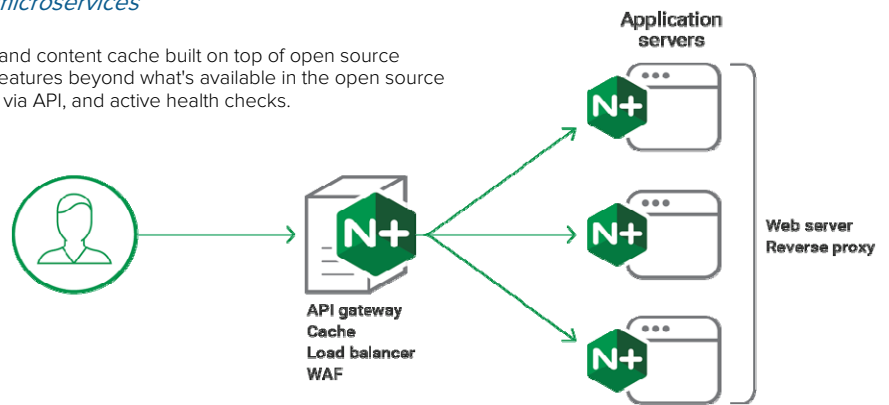

Description

For ordering information, see the NGINX website or contact your F5 representative.

Part Number

N/A

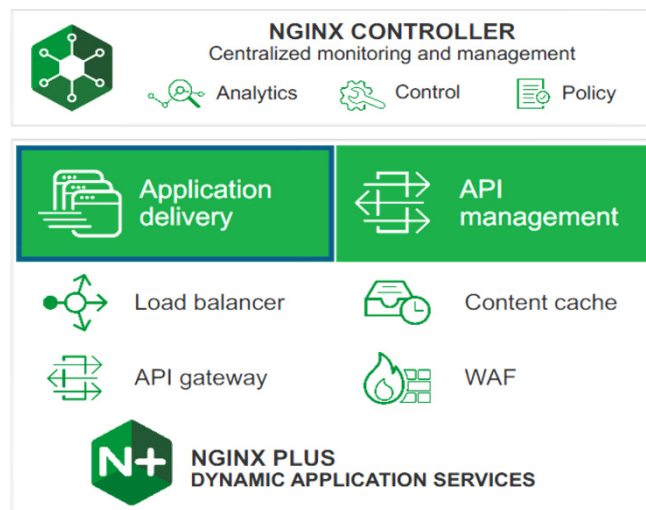

BETTER AND BEST BUNDLES

License application services through product bundles

F5's product bundles let you choose from available modules, with standardised images and fewer configurations. Plus, you can save up to 65% over buying the modules as individual components. Get advanced traffic management, optimisation, and security services on one BIG-IP platform. With Good, Better, and Best options, you can find the right fit to address your business challenges.



- **Good:** Intelligent local traffic management for increased operational and peak network performance of applications
- **Better:** The capabilities of Good, along with advanced application delivery optimisation
- **Best:** The capabilities of Better, plus advanced access management and application security

BIG-IP Virtual Edition Best Bundles

Choose the right fit

Better and Best bundles are available as either a Virtual Edition subscription or through an Enterprise License Agreement. Both options cover your application in public, private, or multi-cloud environments. You can self-license any number of virtual instances, in any capacity, at any time.

Description	Part Number
BIG-IP Virtual Edition Best Bundle 10 Gbps (v12.1.x - v18.x)	F5-BIG-VE-BT-10G-V18
BIG-IP Virtual Edition Best Bundle 5 Gbps (v12.1.x - v18.x)	F5-BIG-VE-BT-5G-V18
BIG-IP Virtual Edition Best Bundle 3 Gbps (v12.1.x - v18.x)	F5-BIG-VE-BT-3G-V18
BIG-IP Virtual Edition Best Bundle 1 Gbps (v12.1.x - v18.x)	F5-BIG-VE-BT-1G-V18
BIG-IP Virtual Edition Best Bundle 200 Mbps (v12.1.x - v18.x)	F5-BIG-VE-BT-200MV18
BIG-IP Virtual Edition Best Bundle 25 Mbps (v12.1.x - v18.x)	F5-BIG-VE-BT-25M-V18
BIG-IP Virtual Edition Best Bundle License Upgrade (5 Gbps to 10 Gbps)	F5-ADD-BIG-VEUPBT10G
BIG-IP Virtual Edition Best Bundle License Upgrade (3 Gbps to 5 Gbps)	F5-ADD-BIG-VE-UPBT5G
BIG-IP Virtual Edition Best Bundle License Upgrade (1 Gbps to 3 Gbps)	F5-ADD-BIG-VE-UPBT3G
BIG-IP Virtual Edition Best Bundle License Upgrade (200 Mbps to 1 Gbps)	F5-ADD-BIG-VE-UPBT1G
BIG-IP Virtual Edition Best Bundle License Upgrade (25 Mbps to 200 Mbps)	F5-ADD-BIGVEUPBT200M

BIG-IP Virtual Edition Better Bundles

Description	Part Number
BIG-IP Virtual Edition Better Bundle 10 Gbps (v12.1.x - v18.x)	F5-BIG-VE-BR-10G-V18
BIG-IP Virtual Edition Better Bundle 5 Gbps (v12.1.x - v18.x)	F5-BIG-VE-BR-5G-V18
BIG-IP Virtual Edition Better Bundle 3 Gbps (v12.1.x - v18.x)	F5-BIG-VE-BR-3G-V18
BIG-IP Virtual Edition Better Bundle 1 Gbps (v12.1.x - v18.x)	F5-BIG-VE-BR-1G-V18
BIG-IP Virtual Edition Better Bundle 200 Mbps (v12.1.x - v18.x)	F5-BIG-VE-BR-200MV18
BIG-IP Virtual Edition Better Bundle 25 Mbps (v12.1.x - v18.x)	F5-BIG-VE-BR-25M-V18
BIG-IP Virtual Edition Better Bundle License Upgrade (5 Gbps to 10 Gbps)	F5-ADD-BIG-VEUPBR10G
BIG-IP Virtual Edition Better Bundle License Upgrade (3 Gbps to 5 Gbps)	F5-ADD-BIG-VE-UPBR5G
BIG-IP Virtual Edition Better Bundle License Upgrade (1 Gbps to 3 Gbps)	F5-ADD-BIG-VE-UPBR3G
BIG-IP Virtual Edition Better Bundle License Upgrade (200 Mbps to 1 Gbps)	F5-ADD-BIG-VE-UPBR1G
BIG-IP Virtual Edition Better Bundle License Upgrade (25 Mbps to 200 Mbps)	F5-ADD-BIGVEUPBR200M

Best Bundle Upgrades for BIG-IP Virtual Edition

Description	Part Number
BIG-IP Virtual Edition Better to Best Bundle Upgrade 10 Gbps	F5-ADDBIGVE-BRBT-10G
BIG-IP Virtual Edition Better to Best Bundle Upgrade 5 Gbps	F5-ADD-BIGVE-BRBT-5G
BIG-IP Virtual Edition Better to Best Bundle Upgrade 3 Gbps	F5-ADD-BIGVE-BRBT-3G
BIG-IP Virtual Edition Better to Best Bundle Upgrade 1 Gbps	F5-ADD-BIGVE-BRBT-1G
BIG-IP Virtual Edition Better to Best Bundle Upgrade 200 Mbps	F5-ADDBIGVEBRBT-200M
BIG-IP Virtual Edition Better to Best Bundle Upgrade 25 Mbps	F5-ADDBIGVE-BRBT-25M
BIG-IP Virtual Edition Local Traffic Manager to Best Bundle Upgrade 10 Gbps	F5-ADD-BIG-VE-GBT10G
BIG-IP Virtual Edition Local Traffic Manager to Best Bundle Upgrade 5 Gbps	F5-ADD-BIG-VE-GBT-5G

BIG-IP Virtual Edition Local Traffic Manager to Best Bundle Upgrade 3 Gbps	F5-ADD-BIG-VE-GBT-3G
BIG-IP Virtual Edition Local Traffic Manager to Best Bundle Upgrade 1 Gbps	F5-ADD-BIG-VE-GBT-1G
BIG-IP Virtual Edition Local Traffic Manager to Best Bundle Upgrade 200 Mbps	F5-ADD-BIG-VEGBT200M
BIG-IP Virtual Edition Local Traffic Manager to Best Bundle Upgrade 25 Mbps	F5-ADD-BIG-VE-GBT25M

Better Bundle Upgrades for BIG-IP Virtual Edition

Description	Part Number
BIG-IP Virtual Edition Local Traffic Manager to Better Bundle Upgrade 10 Gbps	F5-ADD-BIG-VE-GBR10G
BIG-IP Virtual Edition Local Traffic Manager to Better Bundle Upgrade 5 Gbps	F5-ADD-BIG-VE-GBR-5G
BIG-IP Virtual Edition Local Traffic Manager to Better Bundle Upgrade 3 Gbps	F5-ADD-BIG-VE-GBR-3G
BIG-IP Virtual Edition Local Traffic Manager to Better Bundle Upgrade 1 Gbps	F5-ADD-BIG-VE-GBR-1G
BIG-IP Virtual Edition Local Traffic Manager to Better Bundle Upgrade 200 Mbps	F5-ADD-BIG-VEGBR200M
BIG-IP Virtual Edition Local Traffic Manager to Better Bundle Upgrade 25 Mbps	F5-ADD-BIG-VE-GBR25M

BIG-IP iSeries Best Bundles

Description	Part Number
BIG-IP i15800 Best Bundle (512 GB Memory, SSD, Max SSL, Max Compression, vCMP, Dual AC Power Supplies)	F5-BIG-BT-i15800
BIG-IP i11800 Best Bundle Turbo SSL (256 GB Memory, Dual SSD, Max SSL, Max Compression, vCMP, Dual AC Power Supplies)	F5-BIG-BT-i11800-DS
BIG-IP i11800 Best Bundle (256 GB Memory, SSD, Max SSL, Max Compression, vCMP, Dual AC Power Supplies)	F5-BIG-BT-i11800
BIG-IP i10800 Best Bundle (128 GB Memory, Dual SSD, Max SSL, Max Compression, vCMP, Dual AC Power Supplies)	F5-BIG-BT-i10800-D
BIG-IP i10800 Best Bundle (128 GB Memory, SSD, Max SSL, Max Compression, vCMP, Dual AC Power Supplies)	F5-BIG-BT-i10800
BIG-IP i7800 Best Bundle (96 GB Memory, Dual SSD, Max SSL, Max Compression, vCMP, Dual AC Power Supplies)	F5-BIG-BT-i7800-D
BIG-IP i7800 Best Bundle (96 GB Memory, SSD, Max SSL, Max Compression, vCMP, Dual AC Power Supplies)	F5-BIG-BT-i7800
BIG-IP i5800 Best Bundle (48 GB Memory, SSD, Max SSL, Max Compression, vCMP)	F5-BIG-BT-i5800
BIG-IP i4800 Best Bundle (32 GB Memory, Max SSL, Max Compression)	F5-BIG-BT-i4800
BIG-IP i2800 Best Bundle (16 GB Memory, Max SSL, Max Compression)	F5-BIG-BT-i2800
BIG-IP i15600 Best Bundle (512 GB Memory, SSD, Base SSL, Base Compression, Dual AC Power Supplies)	F5-BIG-BT-i15600
BIG-IP i11600 Best Bundle Turbo SSL (256 GB Memory, Dual SSD, Base SSL, Base Compression, vCMP, Dual AC Power Supplies)	F5-BIG-BT-i11600-DS
BIG-IP i11600 Best Bundle (256 GB Memory, SSD, Base SSL, Base Compression, Dual AC Power Supplies)	F5-BIG-BT-i11600
BIG-IP i11400 Best Bundle Turbo SSL (256 GB Memory, Dual SSD, Base SSL, Base Compression, vCMP, Dual AC Power Supplies)	F5-BIG-BT-i11400-DS
BIG-IP i10600 Best Bundle (128 GB Memory, Dual SSD, Base SSL, Base Compression, Dual AC Power Supplies)	F5-BIG-BT-i10600-D
BIG-IP i10600 Best Bundle (128 GB Memory, SSD, Base SSL, Base Compression, Dual AC Power Supplies)	F5-BIG-BT-i10600
BIG-IP i7600 Best Bundle (96 GB Memory, Dual SSD, Base SSL, Base Compression, Dual AC Power Supplies)	F5-BIG-BT-i7600-D
BIG-IP i7600 Best Bundle (96 GB Memory, SSD, Base SSL, Base Compression, Dual AC Power Supplies)	F5-BIG-BT-i7600
BIG-IP i5600 Best Bundle (48 GB Memory, SSD, Base SSL, Base Compression)	F5-BIG-BT-i5600
BIG-IP i4600 Best Bundle (32 GB Memory, Base SSL, Base Compression)	F5-BIG-BT-i4600
BIG-IP i7820 Best Bundle FIPS (96 GB Memory, Dual SSD, Hardware Security Module, Max SSL, Max Compression, vCMP, Dual AC Power Supplies)	F5-BIG-BT-i7820-DF
BIG-IP i5820 Best Bundle FIPS (48 GB Memory, Dual SSD, Hardware Security Module, Max SSL, Max Compression, vCMP)	F5-BIG-BT-i5820-DF
BIG-IP i10350v Best Bundle FIPS (128 GB Memory, SSD, Hardware Security Module, Max SSL, Max Compression, Dual AC Power Supplies)	F5-BIG-BT-i10350V-F
BIG-IP i15800 Best Bundle NEBS (512 GB Memory, SSD, Max SSL, Max Compression, vCMP, Dual DC Power Supplies, NEBS Level 3 Certified)	F5-BIG-BT-i15800-N
BIG-IP i15600 Best Bundle NEBS (512 GB Memory, SSD, Base SSL, Base Compression, Dual DC Power Supplies, NEBS Level 3 Certified)	F5-BIG-BT-i15600-N
BIG-IP i10150s Best Bundle NEBS (128 GB Memory, SSD, Max SSL, Max Compression, Dual DC Power Supplies only, NEBS Level 3 Certified)	F5-BIG-BT-i10150S-N
BIG-IP i10350v Best Bundle NEBS (128 GB Memory, SSD, Max SSL, Max Compression, vCMP, Dual DC Power Supplies only, NEBS Level 3 Certified)	F5-BIG-BT-i10350V-N

BIG-IP iSeries Better Bundles

Description	Part Number
BIG-IP i15800 Better Bundle (512 GB Memory, SSD, Max SSL, Max Compression, vCMP, Dual AC Power Supplies)	F5-BIG-BR-i15800
BIG-IP i11800 Better Bundle Turbo SSL (256 GB Memory, Dual SSD, Max SSL, Max Compression, vCMP, Dual AC Power Supplies)	F5-BIG-BR-i11800-DS
BIG-IP i11800 Better Bundle (256 GB Memory, SSD, Max SSL, Max Compression, vCMP, Dual AC Power Supplies)	F5-BIG-BR-i11800
BIG-IP i10800 Better Bundle (128 GB Memory, Dual SSD, Max SSL, Max Compression, vCMP, Dual AC Power Supplies)	F5-BIG-BR-i10800-D
BIG-IP i10800 Better Bundle (128 GB Memory, SSD, Max SSL, Max Compression, vCMP, Dual AC Power Supplies)	F5-BIG-BR-i10800
BIG-IP i7800 Better Bundle (96 GB Memory, Dual SSD, Max SSL, Max Compression, vCMP, Dual AC Power Supplies)	F5-BIG-BR-i7800-D
BIG-IP i7800 Better Bundle (96 GB Memory, SSD, Max SSL, Max Compression, vCMP, Dual AC Power Supplies)	F5-BIG-BR-i7800
BIG-IP i5800 Better Bundle (48 GB Memory, SSD, Max SSL, Max Compression, vCMP)	F5-BIG-BR-i5800
BIG-IP i4800 Better Bundle (32 GB Memory, Max SSL, Max Compression)	F5-BIG-BR-i4800
BIG-IP i2800 Better Bundle (16 GB Memory, Max SSL, Max Compression)	F5-BIG-BR-i2800
BIG-IP i15600 Better Bundle (512 GB Memory, SSD, Base SSL, Base Compression, Dual AC Power Supplies)	F5-BIG-BR-i15600
BIG-IP i11600 Better Bundle Turbo SSL (256 GB Memory, Dual SSD, Base SSL, Base Compression, vCMP, Dual AC Power Supplies)	F5-BIG-BR-i11600-DS
BIG-IP i11600 Better Bundle (256 GB Memory, SSD, Base SSL, Base Compression, Dual AC Power Supplies)	F5-BIG-BR-i11600
BIG-IP i11400 Better Bundle Turbo SSL (256 GB Memory, Dual SSD, Base SSL, Base Compression, vCMP, Dual AC Power Supplies)	F5-BIG-BR-i11400-DS

BIG-IP i10600 Better Bundle (128 GB Memory, Dual SSD, Base SSL, Base Compression, Dual AC Power Supplies)	F5-BIG-BR-I10600-D
BIG-IP i10600 Better Bundle (128 GB Memory, SSD, Base SSL, Base Compression, Dual AC Power Supplies)	F5-BIG-BR-I10600
BIG-IP i7600 Better Bundle (96 GB Memory, Dual SSD, Base SSL, Base Compression, Dual AC Power Supplies)	F5-BIG-BR-I7600-D
BIG-IP i7600 Better Bundle (96 GB Memory, SSD, Base SSL, Base Compression, Dual AC Power Supplies)	F5-BIG-BR-I7600
BIG-IP i5600 Better Bundle (48 GB Memory, SSD, Base SSL, Base Compression)	F5-BIG-BR-I5600
BIG-IP i4600 Better Bundle (32 GB Memory, Base SSL, Base Compression)	F5-BIG-BR-I4600
BIG-IP i7820 Better Bundle FIPS (96 GB Memory, Dual SSD, Hardware Security Module, Max SSL, Max Compression, vCMP, Dual AC Power Supplies)	F5-BIG-BR-I7820-DF
BIG-IP i5820 Better Bundle FIPS (48 GB Memory, Dual SSD, Hardware Security Module, Max SSL, Max Compression, vCMP)	F5-BIG-BR-I5820-DF
BIG-IP 10350v Better Bundle FIPS (128 GB Memory, SSD, Hardware Security Module, Max SSL, Max Compression, Dual AC Power Supplies)	F5-BIG-BR-10350V-F
BIG-IP i15800 Better Bundle NEBS (512 GB Memory, SSD, Max SSL, Max Compression, vCMP, Dual DC Power Supplies, NEBS Level 3 Certified)	F5-BIG-BR-I15800-N
BIG-IP i15600 Better Bundle NEBS (512 GB Memory, SSD, Base SSL, Base Compression, Dual DC Power Supplies, NEBS Level 3 Certified)	F5-BIG-BR-I15600-N
BIG-IP 10150s Better Bundle NEBS (128 GB Memory, SSD, Max SSL, Max Compression, Dual DC Power Supplies only, NEBS Level 3 Certified)	F5-BIG-BR-10150S-N
BIG-IP 10350v Better Bundle NEBS (128 GB Memory, SSD, Max SSL, Max Compression, vCMP, Dual DC Power Supplies only, NEBS Level 3 Certified)	F5-BIG-BR-10350V-N

Best Bundle Upgrades for BIG-IP iSeries

Description	Part Number
BIG-IP Local Traffic Manager to Best Bundle Upgrade for i15800	F5-ADD-BIG-GBT1158XX
BIG-IP Local Traffic Manager to Best Bundle Upgrade for i11800	F5-ADD-BIG-GBT1118XX
BIG-IP Local Traffic Manager to Best Bundle Upgrade for i10800	F5-ADD-BIG-GBT1108XX
BIG-IP Local Traffic Manager to Best Bundle Upgrade for i7800	F5-ADD-BIG-GBT-I78XX
BIG-IP Local Traffic Manager to Best Bundle Upgrade for i5800	F5-ADD-BIG-GBT-I58XX
BIG-IP Local Traffic Manager to Best Bundle Upgrade for i4800	F5-ADD-BIG-GBT-I48XX
BIG-IP Local Traffic Manager to Best Bundle Upgrade for i2800	F5-ADD-BIG-GBT-I28XX
BIG-IP Local Traffic Manager to Best Bundle Upgrade for i15600	F5-ADD-BIG-GBT1156XX
BIG-IP Local Traffic Manager to Best Bundle Upgrade for i11600	F5-ADD-BIG-GBT1116XX
BIG-IP Local Traffic Manager to Best Bundle Upgrade for i11400	F5-ADD-BIG-GBT1114XX
BIG-IP Local Traffic Manager to Best Bundle Upgrade for i10600	F5-ADD-BIG-GBT1106XX
BIG-IP Local Traffic Manager to Best Bundle Upgrade for i7600	F5-ADD-BIG-GBT-I76XX
BIG-IP Local Traffic Manager to Best Bundle Upgrade for i5600	F5-ADD-BIG-GBT-I56XX
BIG-IP Local Traffic Manager to Best Bundle Upgrade for i4600	F5-ADD-BIG-GBT-I46XX
BIG-IP Local Traffic Manager to Best Bundle Upgrade for 10X5Xs	F5-ADD-BIG-GBT100X0S
BIG-IP Better to Best Bundle Upgrade for i15800	F5-ADD-BIGBRBT1158XX
BIG-IP Better to Best Bundle Upgrade for i11800	F5-ADD-BIGBRBT1118XX
BIG-IP Better to Best Bundle Upgrade for i10800	F5-ADD-BIGBRBT1108XX
BIG-IP Better to Best Bundle Upgrade for i7800	F5-ADD-BIG-BRBT178XX
BIG-IP Better to Best Bundle Upgrade for i5800	F5-ADD-BIG-BRBT158XX
BIG-IP Better to Best Bundle Upgrade for i4800	F5-ADD-BIG-BRBT148XX
BIG-IP Better to Best Bundle Upgrade for i2800	F5-ADD-BIG-BRBT128XX
BIG-IP Better to Best Bundle Upgrade for i15600	F5-ADD-BIGBRBT1156XX
BIG-IP Better to Best Bundle Upgrade for i11600	F5-ADD-BIGBRBT1116XX
BIG-IP Better to Best Bundle Upgrade for i11400	F5-ADD-BIGBRBT1114XX
BIG-IP Better to Best Bundle Upgrade for i10600	F5-ADD-BIGBRBT1106XX
BIG-IP Better to Best Bundle Upgrade for i7600	F5-ADD-BIG-BRBT176XX
BIG-IP Better to Best Bundle Upgrade for i5600	F5-ADD-BIG-BRBT156XX
BIG-IP Better to Best Bundle Upgrade for i4600	F5-ADD-BIG-BRBT146XX
BIG-IP Better to Best Bundle Upgrade for 10350v	F5-ADD-BIGBRBT10350V
BIG-IP Better to Best Bundle Upgrade for 10X5Xs	F5-ADDBIGBRBT-100X0S

Better Bundle Upgrades for BIG-IP iSeries

Description	Part Number
BIG-IP Local Traffic Manager to Better Bundle Upgrade for i15800	F5-ADD-BIG-GBR1158XX
BIG-IP Local Traffic Manager to Better Bundle Upgrade for i11800	F5-ADD-BIG-GBR1118XX
BIG-IP Local Traffic Manager to Better Bundle Upgrade for i10800	F5-ADD-BIG-GBR1108XX
BIG-IP Local Traffic Manager to Better Bundle Upgrade for i7800	F5-ADD-BIG-GBR-I78XX
BIG-IP Local Traffic Manager to Better Bundle Upgrade for i5800	F5-ADD-BIG-GBR-I58XX
BIG-IP Local Traffic Manager to Better Bundle Upgrade for i4800	F5-ADD-BIG-GBR-I48XX
BIG-IP Local Traffic Manager to Better Bundle Upgrade for i2800	F5-ADD-BIG-GBR-I28XX
BIG-IP Local Traffic Manager to Better Bundle Upgrade for i15600	F5-ADD-BIG-GBR1156XX
BIG-IP Local Traffic Manager to Better Bundle Upgrade for i11600	F5-ADD-BIG-GBR1116XX
BIG-IP Local Traffic Manager to Better Bundle Upgrade for i11400	F5-ADD-BIG-GBR1114XX
BIG-IP Local Traffic Manager to Better Bundle Upgrade for i10600	F5-ADD-BIG-GBR1106XX
BIG-IP Local Traffic Manager to Better Bundle Upgrade for i7600	F5-ADD-BIG-GBR-I76XX
BIG-IP Local Traffic Manager to Better Bundle Upgrade for i5600	F5-ADD-BIG-GBR-I56XX
BIG-IP Local Traffic Manager to Better Bundle Upgrade for i4600	F5-ADD-BIG-GBR-I46XX

Better and Best Bundles for VIPRION

Description	Part Number
VIPRION Best Bundle for 4800 Chassis	F5-ADD-VPR-BT-C4800
VIPRION Best Bundle for 4480 Chassis	F5-ADD-VPR-BT-C4400
VIPRION Best Bundle for 2X00 Chassis	F5-ADD-VPR-BT-C2X00
VIPRION Better Bundle for 4800 Chassis	F5-ADD-VPR-BR-C4800
VIPRION Better Bundle for 4480 Chassis	F5-ADD-VPR-BR-C4400
VIPRION Better Bundle for 2X00 Chassis	F5-ADD-VPR-BR-C2X00
VIPRION Better to Best Bundle Upgrade for 4800 Chassis	F5-ADDVPR-BRBT-C4800
VIPRION Better to Best Bundle Upgrade for 4480 Chassis	F5-ADDVPR-BRBT-C4400
VIPRION Better to Best Bundle Upgrade for 2X00 Chassis	F5-ADDVPR-BRBT-C2X00

DNS DELIVERY

Hyperscale and protect DNS while optimising global application delivery

BIG-IP DNS improves the performance and availability of global applications by sending users to the closest or best-performing physical, virtual, or cloud environment. It also hyperscales and secures the DNS infrastructure from DDoS attacks. Global server load balancing (GSLB) distributes user application requests based on business policies, data center and cloud service conditions, user location, and application performance.

Key benefits

- Hyperscale DNS up to 100 million RPS
- Protect against DNS attacks to ensure availability
- Improve global application performance
- Deploy flexibly and scale as you grow
- Manage the network efficiently

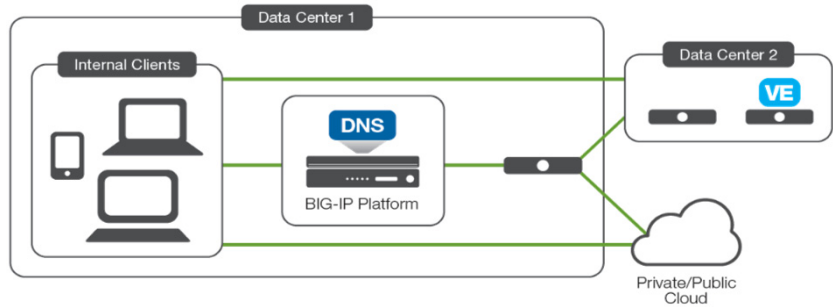

BIG-IP Virtual Edition DNS

Description	Part Number
BIG-IP Virtual Edition DNS License High Performance (GSLB, DNSSEC, Advanced Routing, 8 vCPUs, v13.1.0.2 - v18.x)	F5-BIG-DNS-VE-08-V18
BIG-IP Virtual Edition DNS License (GSLB, DNSSEC, Advanced Routing, 250000 RPS, v12.1.x - v18.x)	F5-BIG-DNS-VE250KV18

DNS Add-on Licenses for BIG-IP Virtual Edition

Description	Part Number
BIG-IP Virtual Edition DNS Max Add-on License High Performance (GSLB, DNSSEC, 4 vCPUs)	F5-ADD-BIG-DNS-VE-04
BIG-IP Virtual Edition DNS Max Add-on License (GSLB, DNSSEC, 250000 RPS)	F5-ADD-BIG-DNS-VE250
BIG-IP Virtual Edition DNS Base Add-on License (GSLB, DNSSEC, 1000 RPS)	F5-ADD-BIG-DNS-VE-1K

BIG-IP iSeries DNS

Description	Part Number
BIG-IP i15800 DNS (512 GB Memory, SSD, Global Server Load Balancing, DNS Services, DNSSEC, Advanced Routing, vCMP, Dual AC Power Supplies)	F5-BIG-DNS-i15800
BIG-IP i11800 DNS (256 GB Memory, SSD, Global Server Load Balancing, DNS Services, DNSSEC, Advanced Routing, vCMP, Dual AC Power Supplies)	F5-BIG-DNS-i11800
BIG-IP i10800 DNS (128 GB Memory, Dual SSD, Global Server Load Balancing, DNS Services, DNSSEC, Advanced Routing, vCMP, Dual AC Power Supplies)	F5-BIG-DNS-i10800-D
BIG-IP i10800 DNS (128 GB Memory, SSD, Global Server Load Balancing, DNS Services, DNSSEC, Advanced Routing, vCMP, Dual AC Power Supplies)	F5-BIG-DNS-i10800
BIG-IP i7800 DNS (96 GB Memory, Dual SSD, Global Server Load Balancing, DNS Services, DNSSEC, Advanced Routing, vCMP, Dual AC Power Supplies)	F5-BIG-DNS-i7800-D
BIG-IP i7800 DNS (96 GB Memory, SSD, Global Server Load Balancing, DNS Services, DNSSEC, Advanced Routing, vCMP, Dual AC Power Supplies)	F5-BIG-DNS-i7800
BIG-IP i5800 DNS (48 GB Memory, SSD, Global Server Load Balancing, DNS Services, DNSSEC, Advanced Routing, vCMP)	F5-BIG-DNS-i5800
BIG-IP i4800 DNS (32 GB Memory, Global Server Load Balancing, DNS Services, DNSSEC, Advanced Routing)	F5-BIG-DNS-i4800
BIG-IP i2800 DNS (16 GB Memory, Global Server Load Balancing, DNS Services, DNSSEC, Advanced Routing)	F5-BIG-DNS-i2800
BIG-IP i15600 DNS (512 GB Memory, SSD, Global Server Load Balancing, DNS Services, DNSSEC, Advanced Routing, Dual AC Power Supplies)	F5-BIG-DNS-i15600
BIG-IP i11600 DNS (256 GB Memory, SSD, Global Server Load Balancing, DNS Services, DNSSEC, Advanced Routing, Dual AC Power Supplies)	F5-BIG-DNS-i11600
BIG-IP i10600 DNS (128 GB Memory, Dual SSD, Global Server Load Balancing, DNS Services, DNSSEC, Advanced Routing, Dual AC Power Supplies)	F5-BIG-DNS-i10600-D
BIG-IP i10600 DNS (128 GB Memory, SSD, Global Server Load Balancing, DNS Services, DNSSEC, Advanced Routing, Dual AC Power Supplies)	F5-BIG-DNS-i10600
BIG-IP i7600 DNS (96 GB Memory, Dual SSD, Global Server Load Balancing, DNS Services, DNSSEC, Advanced Routing, Dual AC Power Supplies)	F5-BIG-DNS-i7600-D
BIG-IP i7600 DNS (96 GB Memory, SSD, Global Server Load Balancing, DNS Services, DNSSEC, Advanced Routing, Dual AC Power Supplies)	F5-BIG-DNS-i7600
BIG-IP i5600 DNS (48 GB Memory, SSD, Global Server Load Balancing, DNS Services, DNSSEC, Advanced Routing)	F5-BIG-DNS-i5600
BIG-IP i4600 DNS (32 GB Memory, Global Server Load Balancing, DNS Services, DNSSEC, Advanced Routing)	F5-BIG-DNS-i4600
BIG-IP i2600 DNS (16 GB Memory, Global Server Load Balancing, DNS Services, DNSSEC, Advanced Routing)	F5-BIG-DNS-i2600
BIG-IP i7820 DNS FIPS (96 GB Memory, Dual SSD, Hardware Security Module, Global Server Load Balancing, DNS Services, DNSSEC, Advanced Routing, vCMP, Dual AC Power Supplies)	F5-BIG-DNS-i7820-DF

BIG-IP i5820 DNS FIPS (48 GB Memory, Dual SSD, Hardware Security Module, Global Server Load Balancing, DNS Services, DNSSEC, Advanced Routing, vCMP)	F5-BIG-DNS-i5820-DF
BIG-IP i15800 DNS NEBS (512 GB Memory, SSD, Global Server Load Balancing, DNS Services, DNSSEC, Advanced Routing, vCMP, Dual DC Power Supplies, NEBS Level 3 Certified)	F5-BIG-DNS-i15800-N
BIG-IP i15600 DNS NEBS (512 GB Memory, SSD, Global Server Load Balancing, DNS Services, DNSSEC, Advanced Routing, Dual DC Power Supplies, NEBS Level 3 Certified)	F5-BIG-DNS-i15600-N
BIG-IP 10150s DNS NEBS (128 GB Memory, SSD, GSLB, DNSSEC, Advanced Routing, Dual DC Power Supplies only, NEBS Level 3 Certified)	F5-BIG-DNS-10150S-N
BIG-IP 10350v DNS NEBS (128 GB Memory, SSD, GSLB, DNSSEC, Advanced Routing, vCMP, Dual DC Power Supplies only, NEBS Level 3 Certified)	F5-BIG-DNS-10350V-N
BIG-IP i2600 Link Controller (16 GB Memory)	F5-BIG-LC-i2600

DNS Add-on Modules for BIG-IP iSeries

Description	Part Number
BIG-IP DNS Max Module (GSLB, DNS, DNSSEC, Advanced Routing, Max RPS)	F5-ADD-BIG-DNS-M
BIG-IP DNS Base Module (GSLB, DNS, DNSSEC, 1000 RPS)	F5-ADD-BIG-DNS-1K
BIG-IP DNS Base to Max Module Upgrade (1000 RPS to Max RPS)	F5-ADD-BIG-DNS-1K-M
BIG-IP DNSSEC Module	F5-ADD-BIG-DNSSEC
BIG-IP DNS Module (DNS Services, Max RPS)	F5-ADD-BIG-DNS
BIG-IP Link Controller Module	F5-ADD-BIG-LC

DNS Add-on Modules for VIPRION

Description	Part Number
VIPRION DNS Max Module (GSLB, DNSSEC, Advanced Routing, Max RPS)	F5-ADD-VPR-DNS-M
VIPRION DNS Base Module (GSLB, DNSSEC, 1000 RPS)	F5-ADD-VPR-DNS-1K
VIPRION DNSSEC Module	F5-ADD-VPR-DNSSEC
VIPRION DNS Module (DNS Services, Max RPS)	F5-ADD-VPR-DNS
VIPRION Advanced Routing Module (RIP, OSPF, BGP, IS-IS, BFD)	F5-ADD-VPR-ROUTING
VIPRION Multicast Routing Module	F5-ADD-VPR-MULTICAST

DNS Cloud Service

Cloud-native SaaS solutions for enhanced application delivery, security, and insight

With DNS Cloud Service, you can easily provision and configure DNS services within a few clicks and begin responding to queries within minutes of activation. DNS Cloud Service is a globally available, cloud-agnostic service that balances the benefits of cloud services with our in-depth DNS expertise in an easy-to-configure solution with built-in security – pay for what you use and scale on demand.

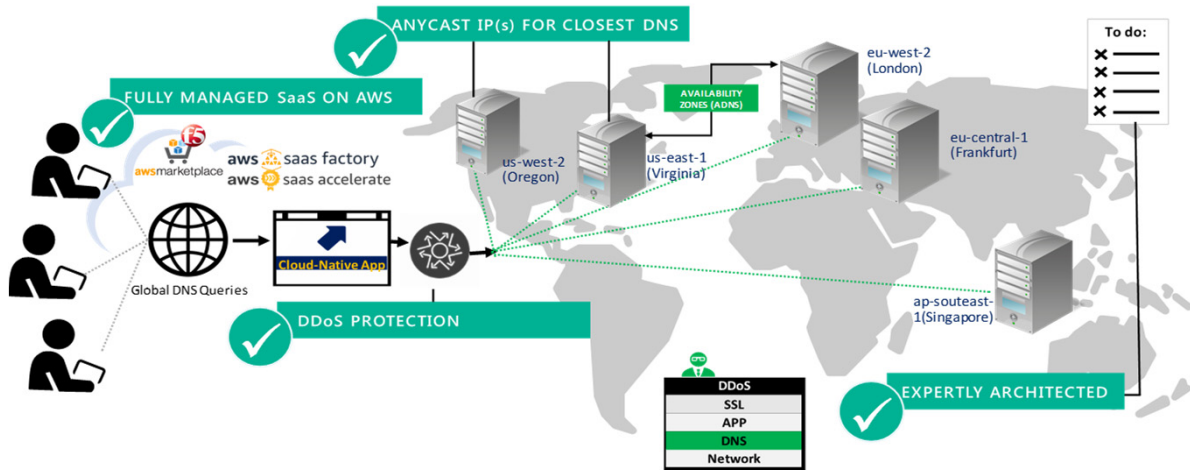

Description	Part Number
For ordering information, see the F5 website or contact your F5 representative.	N/A

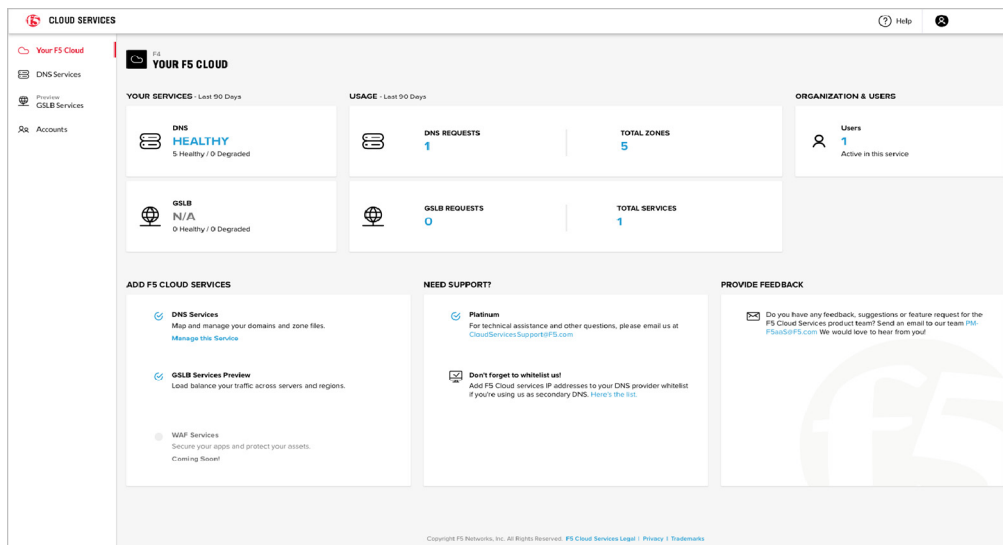

POLICY ENFORCEMENT MANAGER

Improve network performance through effective policy management

With the pervasiveness of mobile devices, IoT, and 5G, your network has to be ready for what's next. BIG-IP Policy Enforcement Manager (PEM) is a policy enforcement function that gives you the network flexibility and control you need while delivering a reliable customer experience. BIG-IP PEM gives you insight into your network's performance and your customers' behaviours, and the tools to act on them.

Key benefits

- Enable new business models and services
- Optimise network performance and video traffic
- Improve subscriber experience
- Consolidate services and reduce costs
- Achieve carrier-grade performance and scalability
- Roll out new services faster

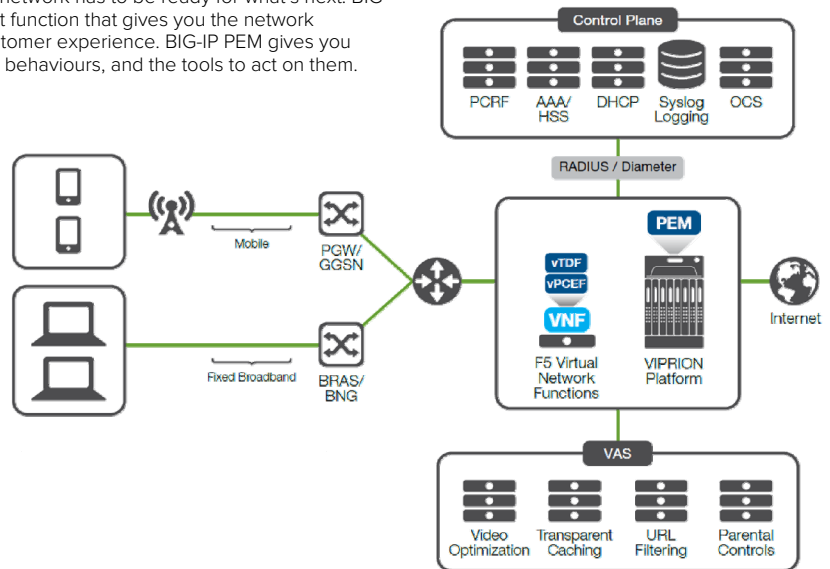

BIG-IP Virtual Edition Policy Enforcement Manager (PEM)

Description	Part Number
BIG-IP Virtual Edition Policy Enforcement Manager High Performance (8 vCPUs, v13.x - v18.x)	F5-BIG-PEM-VE-08-V18
BIG-IP Virtual Edition Policy Enforcement Manager 5 Gbps (v12.1.x - v18.x)	F5-BIG-PEM-VE-5G-V18
BIG-IP Virtual Edition Policy Enforcement Manager 3 Gbps (v12.1.x - v18.x)	F5-BIG-PEM-VE-3G-V18
BIG-IP Virtual Edition Policy Enforcement Manager 1 Gbps (v12.1.x - v18.x)	F5-BIG-PEM-VE-1G-V18
BIG-IP Virtual Edition Policy Enforcement Manager 200 Mbps (v12.1.x - v18.x)	F5-BIG-PEM-VE200MV18
BIG-IP Virtual Edition Basic Policy Enforcement Manager High Performance (8 vCPUs, v13.x - v18.x)	F5-BIG-BPEM-VE-08V18
BIG-IP Virtual Edition Basic Policy Enforcement Manager 5 Gbps (v13.x - v18.x)	F5-BIG-BPEM-VE-5GV18
BIG-IP Virtual Edition Basic Policy Enforcement Manager 3 Gbps (v13.x - v18.x)	F5-BIG-BPEM-VE-3GV18
BIG-IP Virtual Edition Basic Policy Enforcement Manager 1 Gbps (v13.x - v18.x)	F5-BIG-BPEM-VE-1GV18
BIG-IP Virtual Edition Basic Policy Enforcement Manager 200 Mbps (v13.x - v18.x)	F5-BIG-BPEMVE200MV18

Policy Enforcement Manager (PEM) Add-On Licenses for BIG-IP Virtual Edition

Description	Part Number
BIG-IP Virtual Edition Policy Enforcement Manager License Upgrade (3 Gbps to 5 Gbps)	F5-ADD-BIG-PEMVEUP5G
BIG-IP Virtual Edition Policy Enforcement Manager License Upgrade (1 Gbps to 3 Gbps)	F5-ADD-BIG-PEMVEUP3G
BIG-IP Virtual Edition Policy Enforcement Manager License Upgrade (200 Mbps to 1 Gbps)	F5-ADD-BIG-PEMVEUP1G
BIG-IP Virtual Edition Basic Policy Enforcement Manager License Upgrade (3 Gbps to 5 Gbps)	F5-ADD-BIGBPEMVEUP5G
BIG-IP Virtual Edition Basic Policy Enforcement Manager License Upgrade (1 Gbps to 3 Gbps)	F5-ADD-BIGBPEMVEUP3G
BIG-IP Virtual Edition Basic Policy Enforcement Manager License Upgrade (200 Mbps to 1 Gbps)	F5-ADD-BIGBPEMVEUP1G
BIG-IP Virtual Edition Policy Enforcement Manager Add-on License High Performance (4 vCPUs)	F5-ADD-BIG-PEM-VE-04
BIG-IP Virtual Edition Policy Enforcement Manager Add-on License 5 Gbps	F5-ADD-BIG-PEM-VE5G
BIG-IP Virtual Edition Policy Enforcement Manager Add-on License 3 Gbps	F5-ADD-BIG-PEM-VE3G
BIG-IP Virtual Edition Policy Enforcement Manager Add-on License 1 Gbps	F5-ADD-BIG-PEM-VE1G
BIG-IP Virtual Edition Policy Enforcement Manager Add-on License 200 Mbps	F5-ADD-BIG-PEMVE200M
BIG-IP Virtual Edition Basic Policy Enforcement Manager Add-on License High Performance (4 vCPUs)	F5-ADD-BIG-BPEM-VE04
BIG-IP Virtual Edition Basic Policy Enforcement Manager Add-on License 5 Gbps	F5-ADD-BIG-BPEM-VE5G
BIG-IP Virtual Edition Basic Policy Enforcement Manager Add-on License 3 Gbps	F5-ADD-BIG-BPEM-VE3G
BIG-IP Virtual Edition Basic Policy Enforcement Manager Add-on License 1 Gbps	F5-ADD-BIG-BPEM-VE1G
BIG-IP Virtual Edition Basic Policy Enforcement Manager Add-on License 200 Mbps	F5-ADD-BIGBPEMVE200M
BIG-IP Virtual Edition Subscriber Discovery Add-on License High Performance	F5-ADD-BIG-SD-VE-HP
BIG-IP Virtual Edition Subscriber Discovery Add-on License 5 Gbps	F5-ADD-BIG-SD-VE-5G
BIG-IP Virtual Edition Subscriber Discovery Add-on License 3 Gbps	F5-ADD-BIG-SD-VE-3G
BIG-IP Virtual Edition Subscriber Discovery Add-on License 1 Gbps	F5-ADD-BIG-SD-VE-1G
BIG-IP Virtual Edition Subscriber Discovery Add-on License 200 Mbps	F5-ADD-BIG-SD-VE200M
BIG-IP Virtual Edition Dynamic Policy Provisioning Add-on License High Performance	F5-ADD-BIG-DPP-VE-HP
BIG-IP Virtual Edition Dynamic Policy Provisioning Add-on License 5 Gbps	F5-ADD-BIG-DPP-VE-5G
BIG-IP Virtual Edition Dynamic Policy Provisioning Add-on License 3 Gbps	F5-ADD-BIG-DPP-VE-3G
BIG-IP Virtual Edition Dynamic Policy Provisioning Add-on License 1 Gbps	F5-ADD-BIG-DPP-VE-1G

BIG-IP Virtual Edition Dynamic Policy Provisioning Add-on License 200 Mbps	F5-ADD-BIG-DPPVE200M
BIG-IP Virtual Edition Traffic Classification Add-on License High Performance	F5-ADD-BIG-TC-VE-HP
BIG-IP Virtual Edition Traffic Classification Add-on License 5 Gbps	F5-ADD-BIG-TC-VE-5G
BIG-IP Virtual Edition Traffic Classification Add-on License 3 Gbps	F5-ADD-BIG-TC-VE-3G
BIG-IP Virtual Edition Traffic Classification Add-on License 1 Gbps	F5-ADD-BIG-TC-VE-1G
BIG-IP Virtual Edition Traffic Classification Add-on License 200 Mbps	F5-ADD-BIG-TC-VE200M
BIG-IP Virtual Edition Traffic Classification Add-on License High Performance for Basic Policy Enforcement Manager	F5-ADD-BIG-BPTC-VEHP
BIG-IP Virtual Edition Traffic Classification Add-on License 5 Gbps for Basic Policy Enforcement Manager	F5-ADD-BIG-BPTC-VE5G
BIG-IP Virtual Edition Traffic Classification Add-on License 3 Gbps for Basic Policy Enforcement Manager	F5-ADD-BIG-BPTC-VE3G
BIG-IP Virtual Edition Traffic Classification Add-on License 1 Gbps for Basic Policy Enforcement Manager	F5-ADD-BIG-BPTC-VE1G
BIG-IP Virtual Edition Traffic Classification Add-on License 200 Mbps for Basic Policy Enforcement Manager	F5-ADD-BIGBPTCVE200M

URL Filtering Subscription Licenses for BIG-IP Virtual Edition Policy Enforcement Manager (PEM)

Description	Part Number
BIG-IP Virtual Edition URL Filtering License for Policy Enforcement Manager (1-Year Subscription, High Performance)	F5-SBSBIGPEMURLVE41Y
BIG-IP Virtual Edition URL Filtering License for Policy Enforcement Manager (3-Year Subscription, High Performance)	F5-SBSBIGPEMURLVE43Y
BIG-IP Virtual Edition URL Filtering License for Policy Enforcement Manager (1-Year Subscription, 1 Gbps, 3 Gbps, and 5 Gbps)	F5-SBSBIGPEMURLVE21Y
BIG-IP Virtual Edition URL Filtering License for Policy Enforcement Manager (3-Year Subscription, 1 Gbps, 3 Gbps, and 5 Gbps)	F5-SBSBIGPEMURLVE23Y
BIG-IP Virtual Edition URL Filtering License for Policy Enforcement Manager (1-Year Subscription, 200 Mbps)	F5-SBSBIGPEMURLVE11Y
BIG-IP Virtual Edition URL Filtering License for Policy Enforcement Manager (3-Year Subscription, 200 Mbps)	F5-SBSBIGPEMURLVE13Y

BIG-IP iSeries Policy Enforcement Manager (PEM)

Description	Part Number
BIG-IP i15800 Policy Enforcement Manager (512 GB Memory, SSD, Dual AC Power Supplies)	F5-BIG-PEM-I15800
BIG-IP i11800 Policy Enforcement Manager Turbo SSL (256 GB Memory, Dual SSD, Dual AC Power Supplies)	F5-BIG-PEM-I11800-DS
BIG-IP i11800 Policy Enforcement Manager (256 GB Memory, SSD, Dual AC Power Supplies)	F5-BIG-PEM-I11800
BIG-IP i10800 Policy Enforcement Manager (128 GB Memory, Dual SSD, Dual AC Power Supplies)	F5-BIG-PEM-I10800-D
BIG-IP i10800 Policy Enforcement Manager (128 GB Memory, SSD, Dual AC Power Supplies)	F5-BIG-PEM-I10800
BIG-IP i7800 Policy Enforcement Manager (96 GB Memory, Dual SSD, Dual AC Power Supplies)	F5-BIG-PEM-I7800-D
BIG-IP i7800 Policy Enforcement Manager (96 GB Memory, SSD, Dual AC Power Supplies)	F5-BIG-PEM-I7800
BIG-IP i5800 Policy Enforcement Manager (48 GB Memory, SSD)	F5-BIG-PEM-I5800
BIG-IP i15800 Policy Enforcement Manager NEBS (512 GB Memory, SSD, Dual DC Power Supplies, NEBS Level 3 Certified)	F5-BIG-PEM-I15800-N
BIG-IP 10350v Policy Enforcement Manager NEBS (128 GB Memory, SSD, Dual DC Power Supplies only, NEBS Level 3 Certified)	F5-BIG-PEM-10350V-N

Policy Enforcement Manager (PEM) Add-on Modules for BIG-IP iSeries

Description	Part Number
BIG-IP Policy Enforcement Manager Module for i15X00	F5-ADD-BIG-PEMI15XXX
BIG-IP Policy Enforcement Manager Module for i11X00	F5-ADD-BIG-PEMI11XXX
BIG-IP Policy Enforcement Manager Module for i10X00	F5-ADD-BIG-PEMI10XXX
BIG-IP Policy Enforcement Manager Module for i7X00	F5-ADD-BIG-PEMI7XXX
BIG-IP Policy Enforcement Manager Module for i5X00	F5-ADD-BIG-PEMI5XXX
BIG-IP Policy Enforcement Manager Module for 10X5Xs	F5-ADD-BIG-PEMI10000
BIG-IP Quota Management License for i15X00 Policy Enforcement Manager	F5-ADDBIGPEMQMI15XXX
BIG-IP Quota Management License for i11X00 Policy Enforcement Manager	F5-ADDBIGPEMQMI11XXX
BIG-IP Quota Management License for i10X00 Policy Enforcement Manager	F5-ADDBIGPEMQMI10XXX
BIG-IP Quota Management License for i7X00 Policy Enforcement Manager	F5-ADDBIGPEMQMI7XXX
BIG-IP Quota Management License for i5X00 Policy Enforcement Manager	F5-ADDBIGPEMQMI5XXX
BIG-IP Quota Management License for 10X5Xs Policy Enforcement Manager	F5-ADDBIGPEMQMI10000

URL Filtering Subscription Licenses for BIG-IP iSeries Policy Enforcement Manager (PEM)

Description	Part Number
BIG-IP URL Filtering License for i15X00 Policy Enforcement Manager (1-Year Subscription)	F5-SBS-BIGPEMURL101Y
BIG-IP URL Filtering License for i15X00 Policy Enforcement Manager (3-Year Subscription)	F5-SBS-BIGPEMURL103Y
BIG-IP URL Filtering License for 10350v/i10X00/i11X00 Policy Enforcement Manager (1-Year Subscription)	F5-SBSBIGPEMURL-7-1Y
BIG-IP URL Filtering License for 10350v/i10X00/i11X00 Policy Enforcement Manager (3-Year Subscription)	F5-SBSBIGPEMURL-7-3Y
BIG-IP URL Filtering License for 10X5Xs/i7X00 Policy Enforcement Manager (1-Year Subscription)	F5-SBSBIGPEMURL-6-1Y
BIG-IP URL Filtering License for 10X5Xs/i7X00 Policy Enforcement Manager (3-Year Subscription)	F5-SBSBIGPEMURL-6-3Y
BIG-IP URL Filtering License for i5X00 Policy Enforcement Manager (1-Year Subscription)	F5-SBSBIGPEMURL-5-1Y
BIG-IP URL Filtering License for i5X00 Policy Enforcement Manager (3-Year Subscription)	F5-SBSBIGPEMURL-5-3Y

VIPRION Policy Enforcement Manager (PEM)

Description	Part Number
VIPRION 4800 Policy Enforcement Manager Chassis (8 x Slots, 2 x AC Power Supplies)	F5-VPR-PEM-C4800-AC
VIPRION 4480 Policy Enforcement Manager Chassis (4 x Slots, 4 x AC Power Supplies)	F5-VPR-PEM-C4480-AC
VIPRION 4800 Basic Policy Enforcement Manager Chassis (8 x Slots, 2 x AC Power Supplies)	F5-VPR-BPEM-C4800-AC
VIPRION 4480 Basic Policy Enforcement Manager Chassis (4 x Slots, 4 x AC Power Supplies)	F5-VPR-BPEM-C4480-AC
VIPRION 4800 Policy Enforcement Manager Chassis NEBS (8 x Slots, 2 x DC Power Supplies, NEBS Level 3 Certified)	F5-VPR-PEM-C4800-DCN
VIPRION 4480 Policy Enforcement Manager Chassis NEBS (4 x Slots, 4 x DC Power Supplies, NEBS Level 3 Certified)	F5-VPR-PEM-C4480-DCN
VIPRION 4800 Basic Policy Enforcement Manager Chassis NEBS (8 x Slots, 2 x DC Power Supplies, NEBS Level 3 Certified)	F5-VPR-BPEM-C4800DCN
VIPRION 4480 Basic Policy Enforcement Manager Chassis NEBS (4 x Slots, 4 x DC Power Supplies, NEBS Level 3 Certified)	F5-VPR-BPEM-C4480DCN
VIPRION 4450 Policy Enforcement Manager Blade NEBS (256 GB Memory, 6 x QSFP+ Ports, 2 x QSFP28 Ports, NEBS Level 3 Certified)	F5-VPR-PEM-B4450N
VIPRION 4450 Basic Policy Enforcement Manager Blade NEBS (256 GB Memory, 6 x QSFP+ Ports, 2 x QSFP28 Ports, NEBS Level 3 Certified)	F5-VPR-BPEM-B4450N
VIPRION 2400 Policy Enforcement Manager Chassis (4 x Slots, 2 x AC Power Supplies)	F5-VPR-PEM-C2400-AC
VIPRION 2200 Policy Enforcement Manager Chassis (2 x Slots, 2 x AC Power Supplies)	F5-VPR-PEM-C2200-AC
VIPRION 2400 Basic Policy Enforcement Manager Chassis (4 x Slots, 2 x AC Power Supplies)	F5-VPR-BPEM-C2400-AC
VIPRION 2200 Basic Policy Enforcement Manager Chassis (2 x Slots, 2 x AC Power Supplies)	F5-VPR-BPEM-C2200-AC
VIPRION 2200 Policy Enforcement Manager Chassis (2 x Slots, 2 x DC Power Supplies)	F5-VPR-PEM-C2200-DC
VIPRION 2200 Basic Policy Enforcement Manager Chassis (2 x Slots, 2 x DC Power Supplies)	F5-VPR-BPEM-C2200-DC
VIPRION 2250 Policy Enforcement Manager Blade (64 GB Memory, SSD, 4 x QSFP+ Ports)	F5-VPR-PEM-B2250
VIPRION 2150 Policy Enforcement Manager Blade (32 GB Memory, SSD, 8 x SFP+ Ports with 2 x 10GBASE-SR Transceivers included)	F5-VPR-PEM-B2150
VIPRION 2250 Basic Policy Enforcement Manager Blade (64 GB Memory, SSD, 4 x QSFP+ Ports)	F5-VPR-BPEM-B2250
VIPRION 2150 Basic Policy Enforcement Manager Blade (32 GB Memory, SSD, 8 x SFP+ Ports with 2 x 10GBASE-SR Transceivers included)	F5-VPR-BPEM-B2150

Policy Enforcement Manager (PEM) Add-on Modules for VIPRION

Description	Part Number
VIPRION Policy Enforcement Manager Module for 4800 Chassis	F5-ADD-VPR-PEM-C4800
VIPRION Policy Enforcement Manager Module for 4480 Chassis	F5-ADD-VPR-PEM-C4480
VIPRION Policy Enforcement Manager Module for 2X00 Chassis	F5-ADD-VPR-PEM-C2400
VIPRION Basic Policy Enforcement Manager Module for 4800 Chassis	F5-ADD-VPR-BPEMC4800
VIPRION Basic Policy Enforcement Manager Module for 4480 Chassis	F5-ADD-VPR-BPEMC44X0
VIPRION Basic Policy Enforcement Manager Module for 2X00 Chassis	F5-ADD-VPR-BPEMC2X00
VIPRION Subscriber Discovery License for 4800 Chassis	F5-ADD-VPR-SD-C4800
VIPRION Subscriber Discovery License for 4480 Chassis	F5-ADD-VPR-SD-C44X0
VIPRION Subscriber Discovery License for 2X00 Chassis	F5-ADD-VPR-SD-C2X00
VIPRION Dynamic Policy Provisioning License for 4800 Chassis	F5-ADD-VPR-DPP-C4800
VIPRION Dynamic Policy Provisioning License for 4480 Chassis	F5-ADD-VPR-DPP-C44X0
VIPRION Dynamic Policy Provisioning License for 2X00 Chassis	F5-ADD-VPR-DPP-C2X00
VIPRION Traffic Classification License for 4800 Chassis	F5-ADD-VPR-TC-C4800
VIPRION Traffic Classification License for 4480 Chassis	F5-ADD-VPR-TC-C44X0
VIPRION Traffic Classification License for 2X00 Chassis	F5-ADD-VPR-TC-C2X00
VIPRION Traffic Classification License for 4800 Basic Policy Enforcement Manager	F5-ADD-VPR-BPTCC4800
VIPRION Traffic Classification License for 4480 Basic Policy Enforcement Manager	F5-ADD-VPR-BPTCC44X0
VIPRION Traffic Classification License for 2X00 Basic Policy Enforcement Manager	F5-ADD-VPR-BPTCC2X00
VIPRION Quota Management License for 4800 Policy Enforcement Manager	F5-ADDVPRPEMQM-C4800
VIPRION Quota Management License for 4480 Policy Enforcement Manager	F5-ADDVPRPEMQM-C4400
VIPRION Quota Management License for 2X00 Policy Enforcement Manager	F5-ADDVPRPEMQM-C2X00

URL Filtering Subscription Licenses for VIPRION Policy Enforcement Manager (PEM)

Description	Part Number
VIPRION URL Filtering License for 4800 Policy Enforcement Manager (1-Year Subscription)	F5-SBSVPRPEMURL-4-1Y
VIPRION URL Filtering License for 4800 Policy Enforcement Manager (3-Year Subscription)	F5-SBSVPRPEMURL-4-3Y
VIPRION URL Filtering License for 4480 Policy Enforcement Manager (1-Year Subscription)	F5-SBSVPRPEMURL-3-1Y
VIPRION URL Filtering License for 4480 Policy Enforcement Manager (3-Year Subscription)	F5-SBSVPRPEMURL-3-3Y
VIPRION URL Filtering License for 2400 Policy Enforcement Manager (1-Year Subscription)	F5-SBSVPRPEMURL-2-1Y
VIPRION URL Filtering License for 2400 Policy Enforcement Manager (3-Year Subscription)	F5-SBSVPRPEMURL-2-3Y
VIPRION URL Filtering License for 2200 Policy Enforcement Manager (1-Year Subscription)	F5-SBSVPRPEMURL-1-1Y
VIPRION URL Filtering License for 2200 Policy Enforcement Manager (3-Year Subscription)	F5-SBSVPRPEMURL-1-3Y

VIRTUALISED NETWORK FUNCTION BUNDLES

Packaged NFV solutions for service providers

Leveraging network functions virtualisation (NFV) helps lower costs, increase operational efficiency, and monetise new services. F5's prepackaged, preconfigured NFV solutions simplify the deployment and management of virtualised network. These integrated solution packages for service providers combine F5's leading Virtual Editions (VNFs) with automated lifecycle management in a capacity-based consumption model.

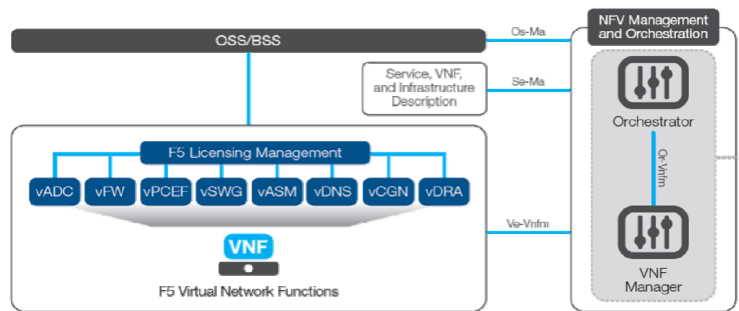

BIG-IP Virtual Edition Virtualized Network Function (VNF) Better and Best Bundles

Description	Part Number
BIG-IP Virtual Edition Virtualized Network Function Best Bundle 10 Gbps (v12.1.x - v18.x)	F5-BIG-VNF3-VE10GV18
BIG-IP Virtual Edition Virtualized Network Function Better Bundle High Performance (12 vCPUs, v13.x - v18.x)	F5-BIG-VNF2-VE-12V18
BIG-IP Virtual Edition Virtualized Network Function Better Bundle 10 Gbps (v12.1.x - v18.x)	F5-BIG-VNF2-VE10GV18

Virtualized Network Function (VNF) Better Bundles for BIG-IP Virtual Edition

Description	Part Number
BIG-IP Virtual Edition Virtualized Network Function Better Bundle Add-on License High Performance (4 vCPUs)	F5-ADD-BIG-VNF2-VE04
BIG-IP Virtual Edition Local Traffic Manager to Virtualized Network Function Better Bundle Upgrade High Performance (4 vCPUs)	F5-ADD-BIG-GVNF2VE04

BIG-IP Virtual Edition VNF Manager

Automated full lifecycle management of VNFs

F5's VNF Manager controls the lifecycle of your VNFs by spinning them up or down as needed, or moving VNFs to different locations. It automates deployment, drives configuration, and manages autoscaling, updates, and upgrades.

Key benefits

- Lower costs
- Enhance security
- Speed time to market
- Provide automated full lifecycle management

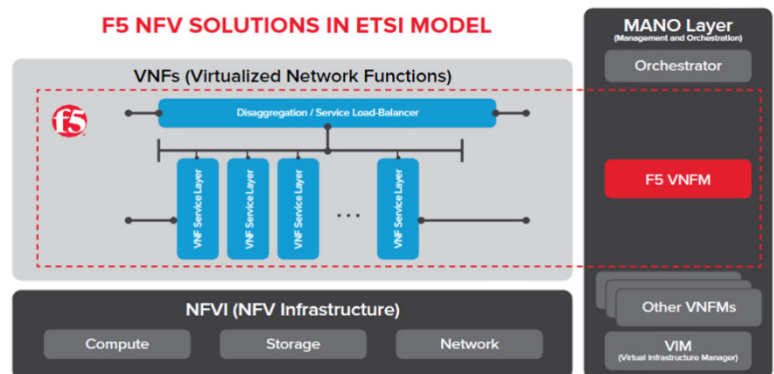

Description	Part Number
BIG-IP Virtual Edition VNF Manager (50 Devices)	F5-BIG-VNF-MGR-VE
BIG-IP Virtual Edition Add-on License for VNF Manager (50 Devices)	F5-ADD-BIG-VNF-VE50
BIG-IP Virtual Edition Add-on License for VNF Manager (500 Devices)	F5-ADD-BIG-VNF-VE500

HARDWARE OPTIONS

Power Supply Options for BIG-IP iSeries

Description	Part Number
BIG-IP Single AC Power Supply for i5X00 (650 W, Field Upgrade)	F5-UPG-AC-I5XXX
BIG-IP Single AC Power Supply for i4X00 (250 W, Field Upgrade)	F5-UPG-AC-I4XXX
BIG-IP Single AC Power Supply for i2X00 (250 W, Field Upgrade)	F5-UPG-AC-I2XXX
BIG-IP Dual DC Power Supplies for i11X00 (650 W, Factory Installed)	F5-OPT-DC-I11XXX
BIG-IP Dual DC Power Supplies for i10X00 (650 W, Factory Installed)	F5-OPT-DC-I10XXX
BIG-IP Dual DC Power Supplies for i7X00 (650 W, Factory Installed)	F5-OPT-DC-I7XXX
BIG-IP Dual DC Power Supplies for i5X00 (650 W, Factory Installed)	F5-OPT-DC-I5XXX
BIG-IP Dual DC Power Supplies for i4X00 (650 W, Factory Installed)	F5-OPT-DC-I4XXX
BIG-IP Dual DC Power Supplies for i2X00 (650 W, Factory Installed)	F5-OPT-DC-I2XXX
BIG-IP Dual DC Power Supplies for 100XXs (850 W, Factory Installed)	F5-OPT-DC-850W
BIG-IP Single DC Power Supply for i15X00 (1500 W, Field Upgrade)	F5-UPG-DC-I15XXX
BIG-IP Single DC Power Supply for i11X00 (650 W, Field Upgrade)	F5-UPG-DC-I11XXX
BIG-IP Single DC Power Supply for i10X00 (650 W, Field Upgrade)	F5-UPG-DC-I10XXX
BIG-IP Single DC Power Supply for i7X00 (650 W, Field Upgrade)	F5-UPG-DC-I7XXX
BIG-IP Single DC Power Supply for i5X00 (650 W, Field Upgrade)	F5-UPG-DC-I5XXX
BIG-IP Single DC Power Supply for i4X00 (650 W, Field Upgrade)	F5-UPG-DC-I4XXX
BIG-IP Single DC Power Supply for i2X00 (650 W, Field Upgrade)	F5-UPG-DC-I2XXX

Hardware Options for BIG-IP iSeries

Description	Part Number
BIG-IP QSFP+ 40GBASE-SR4 BiDi Transceiver (Short Range, 100 m, Field Upgrade)	F5-UPG-QSFP+BD
BIG-IP & VIPRION SFP+ 10GBASE-SR Transceiver (Short Range, 300 m, Field Upgrade)	F5-UPG-SFP+-R
BIG-IP & VIPRION SFP+ 10GBASE-LR Transceiver (Long Range, 10 km, Field Upgrade)	F5-UPG-SFP+LR-R
BIG-IP & VIPRION SFP+ Direct Attach 10GBASE-CX1 Transceiver 8-pack (3 m, Field Upgrade)	F5-UPG-SFPC+-3M-8
BIG-IP & VIPRION SFP 1000BASE-SX Transceiver (Short Range, 550 m, Field Upgrade)	F5-UPG-SFP-R
BIG-IP & VIPRION SFP 1000BASE-LX Transceiver (Long Range, 10 km, Field Upgrade)	F5-UPG-SFPLX-R
BIG-IP & VIPRION SFP 1000BASE-T Transceiver (Field Upgrade)	F5-UPG-SFPC-R
BIG-IP Front Mount Bracket for i4X00/i2X00 (Field Upgrade)	F5-UPG-BRKT-A
BIG-IP Mid Mount Bracket for i11X00/i7X00/i5X00 (Field Upgrade)	F5-UPG-BRKT-B
BIG-IP Mid Mount Bracket for i15X00 (Field Upgrade)	F5-UPG-BRKT-C
BIG-IP Failover Cable 10 Ft (RJ-45)	F5-UPG-CBL-10FT-RJ
BIG-IP Failover Cable 15 Ft (RJ-45)	F5-UPG-CBL-15FT-RJ
BIG-IP Failover Cable 20 Ft (RJ-45)	F5-UPG-CBL-20FT-RJ
BIG-IP Failover Cable 30 Ft (RJ-45)	F5-UPG-CBL-30FT-RJ
BIG-IP Failover Cable 50 Ft (RJ-45)	F5-UPG-CBL-50FT-RJ

Power Supply Options for VIPRION

Description	Part Number
VIPRION Single AC Power Supply for 4800 Chassis (2600 W, Field Upgrade)	F5-UPG-VPR-AC-C4800
VIPRION Single DC Power Supply for 4800 Chassis (2600 W, Field Upgrade)	F5-UPG-VPR-DC-C4800
VIPRION Dual DC Power Supplies for 2400 Chassis (1400 W, Factory Installed)	F5-OPT-VPR-DC-C2400
VIPRION Single DC Power Supply for 2400 Chassis (1400 W, Field Upgrade)	F5-UPG-VPR-DC-C2400
VIPRION Rack-Mount Rails for 2400 Chassis (Field Upgrade)	F5-UPG-VPR-RACKC2400
VIPRION Portable LCD for 2X00 Chassis (Field Upgrade)	F5-UPG-VPR-LCD-C2400
VIPRION Single DC Power Supply for 2200 Chassis (800 W, Field Upgrade)	F5-UPG-VPR-DC-C2200

Hardware Options for VIPRION

Description	Part Number
VIPRION & BIG-IP QSFP+ to 4 x SFP+ Optical Breakout Cable (2-pack, 1 m)	F5-UPG-QSFP+-1M-2
VIPRION & BIG-IP QSFP+ to 4 x SFP+ Optical Breakout Cable (2-pack, 3 m)	F5-UPG-QSFP+-3M-2+
VIPRION & BIG-IP QSFP+ to 4 x SFP+ Optical Breakout Cable (2-pack, 10 m)	F5-UPG-QSFP+-10M-2
VIPRION and BIG-IP QSFP28 100GBASE-SR4 Transceiver (Short Range, 70 m, Field Upgrade)	F5-UPG-QSFP28-SR4
VIPRION and BIG-IP QSFP28 100GBASE-LR4 Transceiver (Long Range, 10 km, Field Upgrade)	F5-UPG-QSFP28-LR4
VIPRION & BIG-IP QSFP+ 40GBASE-SR4 Transceiver (Short Range, 100 m, Field Upgrade)	F5-UPG-QSFP+SR4
VIPRION & BIG-IP QSFP+ 40GBASE-LR4 Transceiver (Long Range, 10 km, Field Upgrade)	F5-UPG-QSFP+LR4
VIPRION & BIG-IP QSFP+ to 4 x LC Duplex Breakout Cable (1.5 m)	F5-UPG-QSFP+AOC1M50
VIPRION & BIG-IP QSFP+ to 4 x LC Duplex Breakout Cable (3 m)	F5-UPG-QSFP+AOC3M
VIPRION & BIG-IP QSFP+ to 4 x LC Duplex Breakout Cable (10 m)	F5-UPG-QSFP+AOC10M

APPLICATION SECURITY

Protect your apps, data, and business

Your apps' data – usernames, passwords, business development plans, IP – is your business's most valuable asset. It's valuable to attackers, too. Today's fast evolving threats often evade traditional defences. Protect your data and your business – think app security first.

F5 web application firewall (WAF) solutions are deployed in more data centers than any enterprise WAF on the market. The comprehensive suite of F5 WAF solutions includes managed rulesets for AWS, self-service and managed services in the F5 Silverline cloud-based platform, ADC integration with BIG-IP Application Security Manager, and BIG-IP Advanced Web Application Firewall.

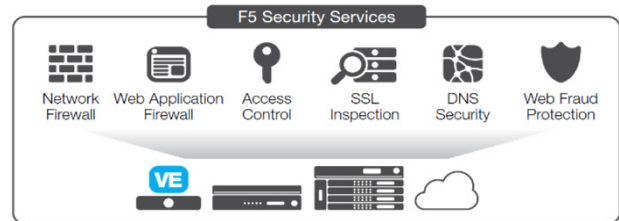

ADVANCED WEB APPLICATION FIREWALL

Identify and block attacks that other WAF solutions miss

Web application firewalls (WAF) protect your applications from data breaches by fixing vulnerabilities and stopping attacks. F5 Advanced Web Application Firewall protects against the latest wave of attacks using behavioural analytics, proactive bot defence, and application-layer encryption of sensitive data, such as credentials – without having to update the apps themselves.

Key benefits

- Protect web and mobile applications from malicious bots
- Safeguard credentials and sensitive data from theft and abuse
- Defend against sophisticated application denial-of-service
- Mitigate sophisticated threat campaigns
- Protect APIs

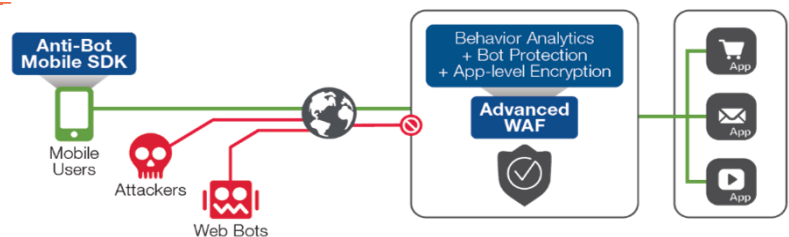

BIG-IP Cloud Edition Advanced Web Application Firewall (AWF)

Description	Part Number
BIG-IP Cloud Edition Advanced Web Application Firewall 200 Mbps (per app, v13.1 - v18.x)	F5-BIG-AWF-PVE200MV18
BIG-IP Cloud Edition Advanced Web Application Firewall 25 Mbps (per app, v13.1 - v18.x)	F5-BIG-AWF-PVE25MV18
BIG-IP Cloud Edition Advanced Web Application Firewall Pool 200 Mbps (per app, 20 instances, v13.1 - v18.x)	F5-BIGAWFPVEP200MV18
BIG-IP Cloud Edition Advanced Web Application Firewall Pool 25 Mbps (per app, 20 instances, v13.1 - v18.x)	F5-BIG-AWFPVEP25MV18
BIG-IP Cloud Edition Advanced Web Application Firewall Add-on License Pool 200 Mbps (per app, 10 instances)	F5-ADDBIGWAFPVEP200M
BIG-IP Cloud Edition Advanced Web Application Firewall Add-on License Pool 25 Mbps (per app, 10 instances)	F5-ADD-BIGWAFPVEP25M

BIG-IP Cloud Edition Local Traffic Manager (LTM) and Advanced Web Application Firewall (AWF)

Description	Part Number
BIG-IP Cloud Edition Local Traffic Manager and Advanced Web Application Firewall 200 Mbps (per app, v13.1 - v18.x)	F5-BIGLTMAWFPVE200MV18
BIG-IP Cloud Edition Local Traffic Manager and Advanced Web Application Firewall 25 Mbps (per app, v13.1 - v18.x)	F5-BIGLTMAWFPVE25MV18
BIG-IP Cloud Edition Local Traffic Manager and Advanced Web Application Firewall Pool 200 Mbps (per app, 20 instances, v13.1 - v18.x)	F5-BIGLTMAWFPVP200MV18
BIG-IP Cloud Edition Local Traffic Manager and Advanced Web Application Firewall Pool 25 Mbps (per app, 20 instances, v13.1 - v18.x)	F5-BIGLTMAWFPVEP25MV18
BIG-IP Cloud Edition Local Traffic Manager and Advanced Web Application Firewall Add-on License Pool 200 Mbps (per app, 10 instances)	F5-ADDBIGLTMAWFPVEP200M
BIG-IP Cloud Edition Local Traffic Manager and Advanced Web Application Firewall Add-on License Pool 25 Mbps (per app, 10 instances)	F5-ADDBIGLTMAWFPVEP25M

BIG-IP Virtual Edition Advanced Web Application Firewall (AWF)

Description	Part Number
BIG-IP Virtual Edition Advanced Web Application Firewall High Performance (8 vCPUs, v13.1.0.2 - v18.x)	F5-BIG-AWF-VE-08-V18
BIG-IP Virtual Edition Advanced Web Application Firewall 1 Gbps (v13.1.0.2 - v18.x)	F5-BIG-AWF-VE-1G-V18
BIG-IP Virtual Edition Advanced Web Application Firewall 200 Mbps (v13.1.0.2 - v18.x)	F5-BIG-AWF-VE200MV18
BIG-IP Virtual Edition Advanced Web Application Firewall 25 Mbps (v13.1.0.2 - v18.x)	F5-BIG-AWF-VE-25MV18
BIG-IP Virtual Edition Advanced Web Application Firewall License Upgrade (25 Mbps to 200 Mbps)	F5-ADDBIGAWFVEUP200M
BIG-IP Virtual Edition Advanced Web Application Firewall License Upgrade (200 Mbps to 1 Gbps)	F5-ADD-BIG-AWFVEUP1G

Advanced Web Application Firewall (AWF) Add-on Licenses for BIG-IP Virtual Edition

Description	Part Number
BIG-IP Virtual Edition Advanced Web Application Firewall Add-on License High Performance (4 vCPUs)	F5-ADD-BIG-AWF-VE-04
BIG-IP Virtual Edition Advanced Web Application Firewall Add-on License 1 Gbps	F5-ADD-BIG-AWF-VE-1G
BIG-IP Virtual Edition Advanced Web Application Firewall Add-on License 200 Mbps	F5-ADD-BIG-AWFVE200M
BIG-IP Virtual Edition Advanced Web Application Firewall Add-on License 25 Mbps	F5-ADD-BIG-AWF-VE25M
BIG-IP Virtual Edition Application Security Manager to Advanced Web Application Firewall Add-on License Upgrade 1 Gbps	F5-ADD-BIGVEASMAWF1G
BIG-IP Virtual Edition Application Security Manager to Advanced Web Application Firewall Add-on License Upgrade 200 Mbps	F5-ADDBIGVEASMAWF200M

BIG-IP iSeries Advanced Web Application Firewall (AWF)

Description	Part Number
BIG-IP i15800 Advanced Web Application Firewall (512 GB Memory, SSD, Max SSL, Max Compression, vCMP, Dual AC Power Supplies)	F5-BIG-AWF-i15800
BIG-IP i11800 Advanced Web Application Firewall Turbo SSL (256 GB Memory, Dual SSD, Max SSL, Max Compression, vCMP, Dual AC Power Supplies)	F5-BIG-AWF-i11800-DS
BIG-IP i11800 Advanced Web Application Firewall (256 GB Memory, SSD, Max SSL, Max Compression, vCMP, Dual AC Power Supplies)	F5-BIG-AWF-i11800
BIG-IP i10800 Advanced Web Application Firewall (128 GB Memory, Dual SSD, Max SSL, Max Compression, vCMP, Dual AC Power Supplies)	F5-BIG-AWF-i10800-D
BIG-IP i10800 Advanced Web Application Firewall (128 GB Memory, SSD, Max SSL, Max Compression, vCMP, Dual AC Power Supplies)	F5-BIG-AWF-i10800
BIG-IP i7800 Advanced Web Application Firewall (96 GB Memory, Dual SSD, Max SSL, Max Compression, vCMP, Dual AC Power Supplies)	F5-BIG-AWF-i7800-D
BIG-IP i7800 Advanced Web Application Firewall (96 GB Memory, SSD, Max SSL, Max Compression, vCMP, Dual AC Power Supplies)	F5-BIG-AWF-i7800
BIG-IP i5800 Advanced Web Application Firewall (48 GB Memory, SSD, Max SSL, Max Compression, vCMP)	F5-BIG-AWF-i5800
BIG-IP i4800 Advanced Web Application Firewall (32 GB Memory, Max SSL, Max Compression)	F5-BIG-AWF-i4800
BIG-IP i2800 Advanced Web Application Firewall (16 GB Memory, Max SSL, Max Compression)	F5-BIG-AWF-i2800
BIG-IP i15600 Advanced Web Application Firewall (512 GB Memory, Dual SSD, Base SSL, Base Compression, Dual AC Power Supplies)	F5-BIG-AWF-i15600
BIG-IP i11600 Advanced Web Application Firewall Turbo SSL (256 GB Memory, Dual SSD, Base SSL, Base Compression, vCMP, Dual AC Power Supplies)	F5-BIG-AWF-i11600-DS
BIG-IP i11600 Advanced Web Application Firewall (256 GB Memory, SSD, Base SSL, Base Compression, Dual AC Power Supplies)	F5-BIG-AWF-i11600
BIG-IP i11400 Advanced Web Application Firewall Turbo SSL (256 GB Memory, Dual SSD, Base SSL, Base Compression, vCMP, Dual AC Power Supplies)	F5-BIG-AWF-i11400-DS
BIG-IP i10600 Advanced Web Application Firewall (128 GB Memory, Dual SSD, Base SSL, Base Compression, Dual AC Power Supplies)	F5-BIG-AWF-i10600-D
BIG-IP i10600 Advanced Web Application Firewall (128 GB Memory, SSD, Base SSL, Base Compression, Dual AC Power Supplies)	F5-BIG-AWF-i10600
BIG-IP i7600 Advanced Web Application Firewall (96 GB Memory, Dual SSD, Base SSL, Base Compression, Dual AC Power Supplies)	F5-BIG-AWF-i7600-D
BIG-IP i7600 Advanced Web Application Firewall (96 GB Memory, SSD, Base SSL, Base Compression, Dual AC Power Supplies)	F5-BIG-AWF-i7600
BIG-IP i5600 Advanced Web Application Firewall (48 GB Memory, SSD, Base SSL, Base Compression)	F5-BIG-AWF-i5600
BIG-IP i4600 Advanced Web Application Firewall (32 GB Memory, Base SSL, Base Compression)	F5-BIG-AWF-i4600
BIG-IP i2600 Advanced Web Application Firewall (16 GB Memory, Base SSL, Base Compression)	F5-BIG-AWF-i2600
BIG-IP i7820 Advanced Web Application Firewall FIPS (96 GB Memory, Dual SSD, Max SSL, Max Compression, vCMP, Dual AC Power Supplies)	F5-BIG-AWF-i7820-DF
BIG-IP i5820 Advanced Web Application Firewall FIPS (48 GB Memory, Dual SSD, Max SSL, Max Compression, vCMP)	F5-BIG-AWF-i5820-DF
BIG-IP i15800 Advanced Web Application Firewall NEBS (512 GB Memory, SSD, Max SSL, Max Compression, vCMP, Dual DC Power Supplies, NEBS Level 3 Certified)	F5-BIG-AWF-i15800-N
BIG-IP i15600 Advanced Web Application Firewall NEBS (512 GB Memory, SSD, Base SSL, Base Compression, Dual DC Power Supplies, NEBS Level 3 Certified)	F5-BIG-AWF-i15600-N

Advanced Web Application Firewall (AWF) Add-on Modules for BIG-IP iSeries

Description	Part Number
BIG-IP Advanced Web Application Firewall Module for i15X00	F5-ADD-BIG-AWF-i15XXX
BIG-IP Advanced Web Application Firewall Module for i11X00	F5-ADD-BIG-AWF-i11XXX
BIG-IP Advanced Web Application Firewall Module for i10X00	F5-ADD-BIG-AWF-i10XXX
BIG-IP Advanced Web Application Firewall Module for i7X00	F5-ADD-BIG-AWF-i7XXX
BIG-IP Advanced Web Application Firewall Module for i5X00	F5-ADD-BIG-AWF-i5XXX
BIG-IP Advanced Web Application Firewall Module for i4X00	F5-ADD-BIG-AWF-i4XXX

BIG-IP Advanced Web Application Firewall Module for i2X00	F5-ADD-BIG-AWF-I2XXX
BIG-IP Application Security Manager to Advanced Web Application Firewall Module Upgrade for i15X00	F5-ADDBIGASMAWFI15XXX
BIG-IP Application Security Manager to Advanced Web Application Firewall Module Upgrade for i11X00	F5-ADDBIGASMAWFI11XXX
BIG-IP Application Security Manager to Advanced Web Application Firewall Module Upgrade for i10X00	F5-ADDBIGASMAWFI10XXX
BIG-IP Application Security Manager to Advanced Web Application Firewall Module Upgrade for i7X00	F5-ADDBIGASMAWFI7XXX
BIG-IP Application Security Manager to Advanced Web Application Firewall Module Upgrade for i5X00	F5-ADDBIGASMAWFI5XXX
BIG-IP Application Security Manager to Advanced Web Application Firewall Module Upgrade for i4X00	F5-ADDBIGASMAWFI4XXX
BIG-IP Application Security Manager to Advanced Web Application Firewall Module Upgrade for i2X00	F5-ADDBIGASMAWFI2XXX

VIPRION Advanced Web Application Firewall (AWF)

Description	Part Number
VIPRION 4800 Advanced Web Application Firewall Chassis (8 x Slots, 2 x AC Power Supplies)	F5-VPR-AWF-C4800-AC
VIPRION 4480 Advanced Web Application Firewall Chassis (4 x Slots, 4 x AC Power Supplies)	F5-VPR-AWF-C4480-AC
VIPRION 4800 Advanced Web Application Firewall Chassis NEBS (8 x Slots, 2 x DC Power Supplies, NEBS Level 3 Certified)	F5-VPR-AWF-C4800-DCN
VIPRION 4480 Advanced Web Application Firewall Chassis NEBS (4 x Slots, 4 x DC Power Supplies, NEBS Level 3 Certified)	F5-VPR-AWF-C4480-DCN
VIPRION 4450 Advanced Web Application Firewall Blade NEBS (256 GB Memory, 6 x QSFP+ Ports, 2 x QSFP28 Ports, NEBS Level 3 Certified)	F5-VPR-AWF-B4450N
VIPRION 2400 Advanced Web Application Firewall Chassis (4 x Slots, 2 x AC Power Supplies)	F5-VPR-AWF-C2400-AC
VIPRION 2200 Advanced Web Application Firewall Chassis (2 x Slots, 2 x AC Power Supplies)	F5-VPR-AWF-C2200-AC
VIPRION 2200 Advanced Web Application Firewall Chassis (2 x Slots, 2 x DC Power Supplies)	F5-VPR-AWF-C2200-DC
VIPRION 2250 Advanced Web Application Firewall Blade (64 GB Memory, SSD, 4 x QSFP+ Ports)	F5-VPR-AWF-B2250
VIPRION 2150 Advanced Web Application Firewall Blade (32 GB Memory, SSD, 8 x SFP+ Ports with 2 x 10GBASE-SR Transceivers included)	F5-VPR-AWF-B2150

Advanced Web Application Firewall (AWF) Add-on Modules for VIPRION

Description	Part Number
VIPRION Advanced Web Application Firewall Module for 4800 Chassis	F5-ADD-VPR-AWF-C4800
VIPRION Advanced Web Application Firewall Module for 4480 Chassis	F5-ADD-VPR-AWF-C44X0
VIPRION Advanced Web Application Firewall Module for 2X00 Chassis	F5-ADD-VPR-AWF-C2X00
VIPRION Application Security Manager to Advanced Web Application Firewall Module Upgrade for 4800 Chassis	F5-ADDVPRASMAWFC4800
VIPRION Application Security Manager to Advanced Web Application Firewall Module Upgrade for 4480 Chassis	F5-ADDVPRASMAWFC44X0
VIPRION Application Security Manager to Advanced Web Application Firewall Module Upgrade for 2X00 Chassis	F5-ADDVPRASMAWFC2X00

DATASAFE

Safeguard credentials and sensitive data from theft and abuse

DataSafe protects credentials and data from threats with application-level field encryption, beyond TLS encryption with protection against client-side vulnerabilities. Sensitive data from the user is automatically encrypted in the browser and remains encrypted until it's decrypted by DataSafe and securely passed to the application.

Key benefits

- Additional layer of protection for data and credentials
- Deployment without modifying applications
- Clientless and seamless to the end user

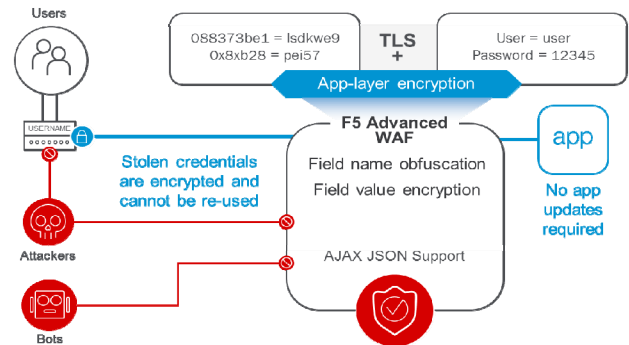

DataSafe Add-on Licenses for BIG-IP Virtual Edition

Description	Part Number
BIG-IP Virtual Edition DataSafe Add-on License 10 Gbps	F5-ADD-BIG-DTS-VE-10G
BIG-IP Virtual Edition DataSafe Add-on License 5 Gbps	F5-ADD-BIG-DTS-VE-5G
BIG-IP Virtual Edition DataSafe Add-on License 3 Gbps	F5-ADD-BIG-DTS-VE-3G
BIG-IP Virtual Edition DataSafe Add-on License 1 Gbps	F5-ADD-BIG-DTS-VE-1G
BIG-IP Virtual Edition DataSafe Add-on License 200 Mbps	F5-ADD-BIG-DTSVE200M
BIG-IP Virtual Edition DataSafe Add-on License 25 Mbps	F5-ADD-BIG-DTS-VE25M

DataSafe Add-on Modules for BIG-IP iSeries

Description	Part Number
BIG-IP DataSafe Module for i15X00	F5-ADD-BIG-DTSI15XXX
BIG-IP DataSafe Module for i11X00	F5-ADD-BIG-DTSI11XXX
BIG-IP DataSafe Module for i10X00	F5-ADD-BIG-DTSI10XXX
BIG-IP DataSafe Module for i7X00	F5-ADD-BIG-DTS-I7XXX
BIG-IP DataSafe Module for i5X00	F5-ADD-BIG-DTS-I5XXX
BIG-IP DataSafe Module for i4X00	F5-ADD-BIG-DTS-I4XXX
BIG-IP DataSafe Module for i2X00	F5-ADD-BIG-DTS-I2XXX

DataSafe Add-on Modules for VIPRION

Description	Part Number
VIPRION DataSafe Module for 4800 Chassis	F5-ADD-VPR-DTS-C4800
VIPRION DataSafe Module for 4480 Chassis	F5-ADD-VPR-DTS-C44X0
VIPRION DataSafe Module for 2X00 Chassis	F5-ADD-VPR-DTS-C2X00

THREAT CAMPAIGNS

Accurate and automated mitigation against specific attack campaigns

Threat Campaigns offer targeted signatures to protect organisations from pervasive attacks that are often coordinated by organised crime and nation states. Based on F5 Labs research, Threat Campaigns provide critical intelligence to fingerprint and mitigate sophisticated attacks with nearly real-time updates.

Key benefits

- Accurate detection – Near zero false positives
- Actionable and relevant – Not just raw data feeds
- Faster mitigation – Lower operational risk
- Minimal IT effort – Reduced TCO

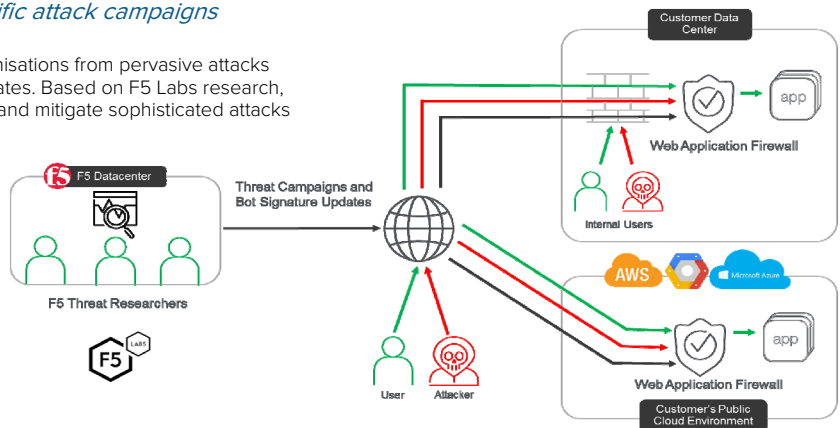

Threat Campaigns Subscription Licenses for BIG-IP Virtual Edition

Description	Part Number
BIG-IP Virtual Edition Threat Campaigns Add-on License for Advanced Web Application Firewall High Performance (1-Year Subscription)	F5-SBS-BIG-VE-TC31YR
BIG-IP Virtual Edition Threat Campaigns Add-on License for Advanced Web Application Firewall High Performance (3-Year Subscription)	F5-SBS-BIG-VE-TC33YR
BIG-IP Virtual Edition Threat Campaigns Add-on License for Advanced Web Application Firewall 1 Gbps (1-Year Subscription)	F5-SBS-BIG-VE-TC21YR
BIG-IP Virtual Edition Threat Campaigns Add-on License for Advanced Web Application Firewall 1 Gbps (3-Year Subscription)	F5-SBS-BIG-VE-TC23YR
BIG-IP Virtual Edition Threat Campaigns Add-on License for Advanced Web Application Firewall 200 Mbps and 25 Mbps (1-Year Subscription)	F5-SBS-BIG-VE-TC11YR
BIG-IP Virtual Edition Threat Campaigns Add-on License for Advanced Web Application Firewall 200 Mbps and 25 Mbps (3-Year Subscription)	F5-SBS-BIG-VE-TC13YR

Threat Campaigns Subscription Licenses for BIG-IP iSeries

Description	Part Number
BIG-IP Threat Campaigns License for i15X00 Advanced Web Application Firewall (1-Year Subscription)	F5-SBS-BIG-TC-4-1YR
BIG-IP Threat Campaigns License for i15X00 Advanced Web Application Firewall (3-Year Subscription)	F5-SBS-BIG-TC-4-3YR
BIG-IP Threat Campaigns License for i11X00/i10X00/10350v/10X5Xs Advanced Web Application Firewall (1-Year Subscription)	F5-SBS-BIG-TC-3-1YR
BIG-IP Threat Campaigns License for i11X00/i10X00/10350v/10X5Xs Advanced Web Application Firewall (3-Year Subscription)	F5-SBS-BIG-TC-3-3YR
BIG-IP Threat Campaigns License for i7X00/i5X00 Advanced Web Application Firewall (1-Year Subscription)	F5-SBS-BIG-TC-2-1YR
BIG-IP Threat Campaigns License for i7X00/i5X00 Advanced Web Application Firewall (3-Year Subscription)	F5-SBS-BIG-TC-2-3YR
BIG-IP Threat Campaigns License for i4X00/i2X00 Advanced Web Application Firewall (1-Year Subscription)	F5-SBS-BIG-TC-1-1YR
BIG-IP Threat Campaigns License for i4X00/i2X00 Advanced Web Application Firewall (3-Year Subscription)	F5-SBS-BIG-TC-1-3YR

Threat Campaigns Subscription Licenses for VIPRION

Description	Part Number
VIPRION Threat Campaigns License for 4800 Advanced Web Application Firewall (1-Year Subscription)	F5-SBS-VPR-TC-4-1YR
VIPRION Threat Campaigns License for 4800 Advanced Web Application Firewall (3-Year Subscription)	F5-SBS-VPR-TC-4-3YR
VIPRION Threat Campaigns License for 4480 Advanced Web Application Firewall (1-Year Subscription)	F5-SBS-VPR-TC-3-1YR
VIPRION Threat Campaigns License for 4480 Advanced Web Application Firewall (3-Year Subscription)	F5-SBS-VPR-TC-3-3YR
VIPRION Threat Campaigns License for 2400 Advanced Web Application Firewall (1-Year Subscription)	F5-SBS-VPR-TC-2-1YR
VIPRION Threat Campaigns License for 2400 Advanced Web Application Firewall (3-Year Subscription)	F5-SBS-VPR-TC-2-3YR
VIPRION Threat Campaigns License for 2200 Advanced Web Application Firewall (1-Year Subscription)	F5-SBS-VPR-TC-1-1YR
VIPRION Threat Campaigns License for 2200 Advanced Web Application Firewall (3-Year Subscription)	F5-SBS-VPR-TC-1-3YR

ANTI-BOT MOBILE SDK

Protect web and mobile applications from malicious bots

Appdome's no-code mobile integration platform enables implementation of F5 Anti-Bot Mobile SDK in minutes, to quickly protect mobile applications. Both developers and non-developers can implement the full functionality of the SDK using a simple "click to implement" user interface.

Key benefits

- Protect what's important
- Rapidly deliver in-depth mobile bot detection
- Provide consistent experience across platforms
- Support multi-service implementations

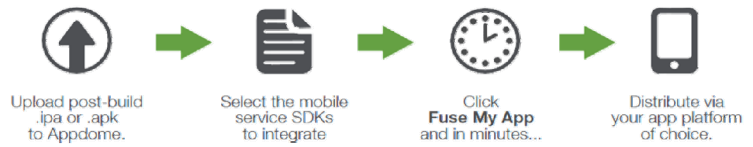

Anti-Bot Mobile SDK Add-on Licenses for BIG-IP Virtual Edition

Description	Part Number
BIG-IP Virtual Edition Anti-Bot Mobile SDK Add-on License 3 Gbps	F5-ADD-BIG-ABM-VE-3G
BIG-IP Virtual Edition Anti-Bot Mobile SDK Add-on License 1 Gbps	F5-ADD-BIG-ABM-VE-1G
BIG-IP Virtual Edition Anti-Bot Mobile SDK Add-on License 200 Mbps	F5-ADD-BIG-ABMVE200M
BIG-IP Virtual Edition Anti-Bot Mobile SDK Add-on License 25 Mbps	F5-ADD-BIG-ABM-VE25M
BIG-IP Virtual Edition Anti-Bot Mobile SDK Add-on License for Advanced Web Application Firewall High Performance	F5-ADD-BIGAWFABMVEHP
BIG-IP Virtual Edition Anti-Bot Mobile SDK Add-on License for Advanced Web Application Firewall 1 Gbps	F5-ADD-BIGAWFABMVE1G
BIG-IP Virtual Edition Anti-Bot Mobile SDK Add-on License for Advanced Web Application Firewall 200 Mbps	F5-ADDBIGAWFABMVE200M
BIG-IP Virtual Edition Anti-Bot Mobile SDK Add-on License for Advanced Web Application Firewall 25 Mbps	F5-ADDBIGAWFABMVE25M

Anti-Bot Mobile SDK Add-on Licenses for BIG-IP iSeries

Description	Part Number
BIG-IP Anti-Bot Mobile SDK License for i15X00	F5-ADD-BIG-ABMI15XXX
BIG-IP Anti-Bot Mobile SDK License for i11X00	F5-ADD-BIG-ABMI11XXX
BIG-IP Anti-Bot Mobile SDK License for i10X00	F5-ADD-BIG-ABMI10XXX
BIG-IP Anti-Bot Mobile SDK License for i7X00	F5-ADD-BIG-ABM-I7XXX
BIG-IP Anti-Bot Mobile SDK License for i5X00	F5-ADD-BIG-ABM-I5XXX
BIG-IP Anti-Bot Mobile SDK License for i4X00	F5-ADD-BIG-ABM-I4XXX
BIG-IP Anti-Bot Mobile SDK License for i2X00	F5-ADD-BIG-ABM-I2XXX
BIG-IP Anti-Bot Mobile SDK Add-on License for i15X00 Advanced Web Application Firewall	F5-ADDBIGAWFABMI15XXX
BIG-IP Anti-Bot Mobile SDK Add-on License for i11X00 Advanced Web Application Firewall	F5-ADDBIGAWFABMI11XXX
BIG-IP Anti-Bot Mobile SDK Add-on License for i10X00 Advanced Web Application Firewall	F5-ADDBIGAWFABMI10XXX
BIG-IP Anti-Bot Mobile SDK Add-on License for i7X00 Advanced Web Application Firewall	F5-ADDBIGAWFABMI7XXX
BIG-IP Anti-Bot Mobile SDK Add-on License for i5X00 Advanced Web Application Firewall	F5-ADDBIGAWFABMI5XXX
BIG-IP Anti-Bot Mobile SDK Add-on License for i4X00 Advanced Web Application Firewall	F5-ADDBIGAWFABMI4XXX
BIG-IP Anti-Bot Mobile SDK Add-on License for i2X00 Advanced Web Application Firewall	F5-ADDBIGAWFABMI2XXX

Anti-Bot Mobile SDK Add-on Licenses for VIPRION

Description	Part Number
VIPRION Anti-Bot Mobile SDK License for 4800 Chassis	F5-ADD-VPR-ABM-C4800
VIPRION Anti-Bot Mobile SDK License for 4480 Chassis	F5-ADD-VPR-ABM-C44X0
VIPRION Anti-Bot Mobile SDK License for 2X00 Chassis	F5-ADD-VPR-ABM-C2X00

APPLICATION SECURITY MANAGER

Defend against web attacks and achieve regulatory compliance

BIG-IP Application Security Manager (ASM) is a web application firewall (WAF), deployed in more data centers than any enterprise WAF on the market. With advanced firewall capabilities, it secures applications against L7 DDoS attacks, malicious bot traffic, and application vulnerabilities where other WAFs fail.

Key benefits

- Ensure application security and compliance
- Turn on protection immediately
- Patch vulnerabilities fast
- Deploy flexibly
- Defend with proven advanced protections
- Magnify threat knowledge

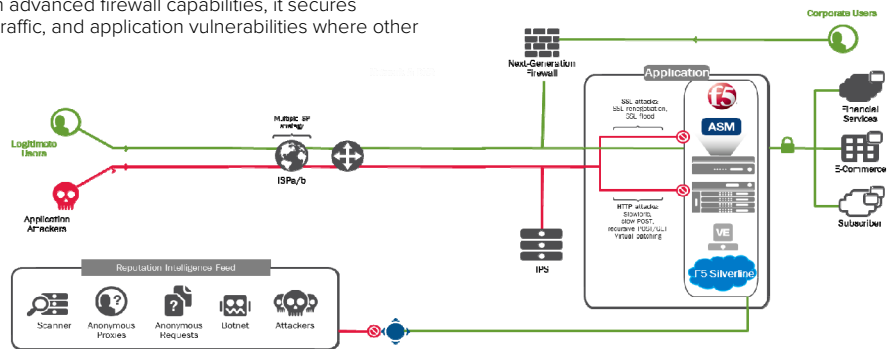

BIG-IP Virtual Edition Application Security Manager (ASM)

Description	Part Number
BIG-IP Virtual Edition Application Security Manager 3 Gbps (v12.1.x - v18.x)	F5-BIG-ASM-VE-3G-V18
BIG-IP Virtual Edition Application Security Manager 1 Gbps (v12.1.x - v18.x)	F5-BIG-ASM-VE-1G-V18
BIG-IP Virtual Edition Application Security Manager 200 Mbps (v12.1.x - v18.x)	F5-BIG-ASMVE200M-V18
BIG-IP Virtual Edition Application Security Manager License Upgrade (1 Gbps to 3 Gbps)	F5-ADD-BIG-ASMVEUP3G
BIG-IP Virtual Edition Application Security Manager License Upgrade (200 Mbps to 1 Gbps)	F5-ADD-BIG-ASMVEUP1G

Application Security Manager (ASM) Add-on Licenses for BIG-IP Virtual Edition

Description	Part Number
BIG-IP Virtual Edition Application Security Manager Add-on License 3 Gbps	F5-ADD-BIG-ASM-VE3G
BIG-IP Virtual Edition Application Security Manager Add-on License 1 Gbps	F5-ADD-BIG-ASM-VE1G
BIG-IP Virtual Edition Application Security Manager Add-on License 200 Mbps	F5-ADD-BIG-ASMVE200M
BIG-IP Virtual Edition Application Security Manager Add-on License 25 Mbps	F5-ADD-BIG-ASM-VE25M

BIG-IP iSeries Application Security Manager (ASM)

Description	Part Number
BIG-IP i15800 Application Security Manager (512 GB Memory, SSD, Max SSL, Max Compression, vCMP, Dual AC Power Suppl	F5-BIG-ASM-i15800
BIG-IP i11800 Application Security Manager (256 GB Memory, SSD, Max SSL, Max Compression, vCMP, Dual AC Power Suppl	F5-BIG-ASM-i11800
BIG-IP i10800 Application Security Manager (128 GB Memory, SSD, Max SSL, Max Compression, vCMP, Dual AC Power Suppl	F5-BIG-ASM-i10800
BIG-IP i7800 Application Security Manager (96 GB Memory, SSD, Max SSL, Max Compression, vCMP, Dual AC Power Supplies	F5-BIG-ASM-i7800
BIG-IP i5800 Application Security Manager (48 GB Memory, SSD, Max SSL, Max Compression, vCMP)	F5-BIG-ASM-i5800
BIG-IP i4800 Application Security Manager (32 GB Memory, Max SSL, Max Compression)	F5-BIG-ASM-i4800
BIG-IP i2800 Application Security Manager (16 GB Memory, Max SSL, Max Compression)	F5-BIG-ASM-i2800
BIG-IP i15600 Application Security Manager (512 GB Memory, SSD, Base SSL, Base Compression, Dual AC Power Supplies)	F5-BIG-ASM-i15600
BIG-IP i11600 Application Security Manager (256 GB Memory, SSD, Base SSL, Base Compression, Dual AC Power Supplies)	F5-BIG-ASM-i11600
BIG-IP i10600 Application Security Manager (128 GB Memory, SSD, Base SSL, Base Compression, Dual AC Power Supplies)	F5-BIG-ASM-i10600
BIG-IP i7600 Application Security Manager (96 GB Memory, SSD, Base SSL, Base Compression, Dual AC Power Supplies)	F5-BIG-ASM-i7600
BIG-IP i5600 Application Security Manager (48 GB Memory, SSD, Base SSL, Base Compression)	F5-BIG-ASM-i5600
BIG-IP i4600 Application Security Manager (32 GB Memory, Base SSL, Base Compression)	F5-BIG-ASM-i4600
BIG-IP i2600 Application Security Manager (16 GB Memory, Base SSL, Base Compression)	F5-BIG-ASM-i2600
BIG-IP i15800 Application Security Manager NEBS (512 GB Memory, SSD, Max SSL, Max Compression, vCMP, Dual DC Power Supplies, NEBS Level 3 Certified)	F5-BIG-ASM-i15800-N
BIG-IP i15600 Application Security Manager NEBS (512 GB Memory, SSD, Base SSL, Base Compression, Dual DC Power Supplies, NEBS Level 3 Certified)	F5-BIG-ASM-i15600-N
BIG-IP i10350v Application Security Manager NEBS (128 GB Memory, SSD, Max SSL, Max Compression, vCMP, Dual DC Power Supplies only, NEBS Level 3 Certified)	F5-BIG-ASM-i10350V-N

Application Security Manager (ASM) Add-on Modules for BIG-IP iSeries

Description	Part Number
BIG-IP Application Security Manager Module for i15X00	F5-ADD-BIG-ASM115XXX
BIG-IP Application Security Manager Module for i11X00	F5-ADD-BIG-ASM111XXX
BIG-IP Application Security Manager Module for i10X00	F5-ADD-BIG-ASM110XXX
BIG-IP Application Security Manager Module for i7X00	F5-ADD-BIG-ASM-I7XXX
BIG-IP Application Security Manager Module for i5X00	F5-ADD-BIG-ASM-I5XXX
BIG-IP Application Security Manager Module for i4X00	F5-ADD-BIG-ASM-I4XXX
BIG-IP Application Security Manager Module for i2X00	F5-ADD-BIG-ASM-I2XXX
BIG-IP Application Security Manager Module for 10X5Xs	F5-ADD-BIG-ASM-10000
BIG-IP Security Bundle for 10X5Xs (Application Security Manager, Access Policy Manager, Max SSL, Max Compression, 500 Concurrent VPN Users)	F5-ADD-BIG-SEC-10000

VIPRION Application Security Manager (ASM)

Description	Part Number
VIPRION 4800 Application Security Manager Chassis (8 x Slots, 2 x AC Power Supplies)	F5-VPR-ASM-C4800-AC
VIPRION 4480 Application Security Manager Chassis (4 x Slots, 4 x AC Power Supplies)	F5-VPR-ASM-C4480-AC
VIPRION 4800 Application Security Manager Chassis NEBS (8 x Slots, 2 x DC Power Supplies, NEBS Level 3 Certified)	F5-VPR-ASM-C4800-DCN
VIPRION 4480 Application Security Manager Chassis NEBS (4 x Slots, 4 x DC Power Supplies, NEBS Level 3 Certified)	F5-VPR-ASM-C4480-DCN
VIPRION 4450 Application Security Manager Blade NEBS (256 GB Memory, 6 x QSFP+ Ports, 2 x QSFP28 Ports, NEBS Level 3 Certified)	F5-VPR-ASM-B4450N
VIPRION 2400 Application Security Manager Chassis (4 x Slots, 2 x AC Power Supplies)	F5-VPR-ASM-C2400-AC
VIPRION 2200 Application Security Manager Chassis (2 x Slots, 2 x AC Power Supplies)	F5-VPR-ASM-C2200-AC
VIPRION 2200 Application Security Manager Chassis (2 x Slots, 2 x DC Power Supplies)	F5-VPR-ASM-C2200-DC
VIPRION 2250 Application Security Manager Blade (64 GB Memory, SSD, 4 x QSFP+ Ports)	F5-VPR-ASM-B2250
VIPRION 2150 Application Security Manager Blade (32 GB Memory, SSD, 8 x SFP+ Ports with 2 x 10GBASE-SR Transceivers included)	F5-VPR-ASM-B2150

Application Security Manager (ASM) Add-on Modules for VIPRION

Description	Part Number
VIPRION Application Security Bundle for 4800 Chassis (Application Security Manager, Max SSL)	F5-ADD-VPR-ASM-C4800
VIPRION Application Security Bundle for 4480 Chassis (Application Security Manager, Max SSL)	F5-ADD-VPR-ASM-C4400
VIPRION Application Security Manager Module for 4800 Chassis	F5-ADD-VPRASM-C4800B
VIPRION Application Security Manager Module for 4480 Chassis	F5-ADD-VPRASM-C4400B
VIPRION Application Security Bundle for 2X00 Chassis (Application Security Manager, Max SSL)	F5-ADD-VPR-ASM-C2400
VIPRION Application Security Manager Module for 2X00 Chassis	F5-ADD-VPRASM-C2400B
VIPRION Security Bundle for 4800 Chassis (Application Security Manager, Access Policy Manager, Max SSL, Max Compression, 500 Concurrent VPN Users)	F5-ADD-VPR-SEC-C4800
VIPRION Security Bundle for 4480 Chassis (Application Security Manager, Access Policy Manager, Max SSL, Max Compression, 500 Concurrent VPN Users)	F5-ADD-VPR-SEC-C4400
VIPRION Security Bundle for 2X00 Chassis (Application Security Manager, Access Policy Manager, Max SSL, Max Compression, 500 Concurrent VPN Users)	F5-ADD-VPR-SEC-C2400

IP INTELLIGENCE SERVICES

Block malicious IP addresses

F5 IP Intelligence Services enhances automated security decisions with IP reputation intelligence. By identifying IP addresses and security categories associated with malicious activity, IP Intelligence Services can incorporate dynamic lists of threatening IP addresses from third parties into the F5 platform, adding context and automation to Advanced WAF blocking decisions.



Key benefits

- Ensure IP threat protection
- Improve visibility into threats from multiple sources
- Enable granular threat reporting and automated blocking
- Optimise protection with real-time updates

IP Intelligence (IPI) Subscription Licenses for BIG-IP Virtual Edition

Description	Part Number
BIG-IP Virtual Edition IP Intelligence License (1-Year Subscription, High Performance)	F5-SBS-BIGVE-IP141YR
BIG-IP Virtual Edition IP Intelligence License (3-Year Subscription, High Performance)	F5-SBS-BIGVE-IP143YR
BIG-IP Virtual Edition IP Intelligence License (1-Year Subscription, 10 Gbps)	F5-SBS-BIGVE-IP131YR
BIG-IP Virtual Edition IP Intelligence License (3-Year Subscription, 10 Gbps)	F5-SBS-BIGVE-IP133YR
BIG-IP Virtual Edition IP Intelligence License (1-Year Subscription, 1 Gbps, 3 Gbps, and 5 Gbps)	F5-SBS-BIGVE-IP121YR
BIG-IP Virtual Edition IP Intelligence License (3-Year Subscription, 1 Gbps, 3 Gbps, and 5 Gbps)	F5-SBS-BIGVE-IP123YR
BIG-IP Virtual Edition IP Intelligence License (1-Year Subscription, 25 Mbps and 200 Mbps)	F5-SBS-BIGVE-IP111YR
BIG-IP Virtual Edition IP Intelligence License (3-Year Subscription, 25 Mbps and 200 Mbps)	F5-SBS-BIGVE-IP113YR

IP Intelligence (IPI) Subscription Licenses for BIG-IP iSeries

Description	Part Number
BIG-IP IP Intelligence License for i15X00 (1-Year Subscription)	F5-SBS-BIG-IP1-101YR
BIG-IP IP Intelligence License for i15X00 (3-Year Subscription)	F5-SBS-BIG-IP1-103YR
BIG-IP IP Intelligence License for 10350v/i10X00/i11X00 (1-Year Subscription)	F5-SBS-BIG-IP1-7-1YR
BIG-IP IP Intelligence License for 10350v/i10X00/i11X00 (3-Year Subscription)	F5-SBS-BIG-IP1-7-3YR
BIG-IP IP Intelligence License for 10X5Xs/i7X00 (1-Year Subscription)	F5-SBS-BIG-IP1-6-1YR
BIG-IP IP Intelligence License for 10X5Xs/i7X00 (3-Year Subscription)	F5-SBS-BIG-IP1-6-3YR
BIG-IP IP Intelligence License for i5X00 (1-Year Subscription)	F5-SBS-BIG-IP1-5-1YR
BIG-IP IP Intelligence License for i5X00 (3-Year Subscription)	F5-SBS-BIG-IP1-5-3YR
BIG-IP IP Intelligence License for i4X00 (1-Year Subscription)	F5-SBS-BIG-IP1-4-1YR
BIG-IP IP Intelligence License for i4X00 (3-Year Subscription)	F5-SBS-BIG-IP1-4-3YR
BIG-IP IP Intelligence License for 2X00s/i2X00 (1-Year Subscription)	F5-SBS-BIG-IP1-3-1YR
BIG-IP IP Intelligence License for 2X00s/i2X00 (3-Year Subscription)	F5-SBS-BIG-IP1-3-3YR

IP Intelligence (IPI) Subscription Licenses for VIPRION

Description	Part Number
VIPRION IP Intelligence License for 4800 Chassis (1-Year Subscription)	F5-SBS-VPR-IP1-4-1YR
VIPRION IP Intelligence License for 4800 Chassis (3-Year Subscription)	F5-SBS-VPR-IP1-4-3YR
VIPRION IP Intelligence License for 4480 Chassis (1-Year Subscription)	F5-SBS-VPR-IP1-3-1YR
VIPRION IP Intelligence License for 4480 Chassis (3-Year Subscription)	F5-SBS-VPR-IP1-3-3YR
VIPRION IP Intelligence License for 2400 Chassis (1-Year Subscription)	F5-SBS-VPR-IP1-2-1YR
VIPRION IP Intelligence License for 2400 Chassis (3-Year Subscription)	F5-SBS-VPR-IP1-2-3YR
VIPRION IP Intelligence License for 2200 Chassis (1-Year Subscription)	F5-SBS-VPR-IP1-1-1YR
VIPRION IP Intelligence License for 2200 Chassis (3-Year Subscription)	F5-SBS-VPR-IP1-1-3YR

INTRUSION PREVENTION SYSTEM

Cost-effectively defend against threats for a broad set of protocols

F5 Intrusion Prevention System is ideal for customers that want to apply additional security controls for a broad set of protocols without deploying a dedicated platform, but are unable to migrate all application traffic because of technical limitations, cost, and operational concerns. Unlike other vendors, the BIG-IP platform provides consolidated DDoS, firewall, and IDS/IPS functionality to enable cost-effective security control for many protocols and threat vectors.

Key benefits

- Savings in CapEx and OpEx
- Security operational simplicity
- Improved performance
- Integrated DDoS protection and ADC

Intrusion Prevention System (IPS) Licenses for BIG-IP Virtual Edition

Description	Part Number
BIG-IP Virtual Edition Intrusion Prevention System Add-on License for Advanced Firewall Manager High Performance	F5-ADD-BIG-IPS-VE-HP
BIG-IP Virtual Edition Intrusion Prevention System Add-on License for Advanced Firewall Manager 10 Gbps	F5-ADD-BIG-IPS-VE10G
BIG-IP Virtual Edition Intrusion Prevention System Add-on License for Advanced Firewall Manager 5 Gbps	F5-ADD-BIG-IPS-VE-5G
BIG-IP Virtual Edition Intrusion Prevention System Add-on License for Advanced Firewall Manager 3 Gbps	F5-ADD-BIG-IPS-VE-3G
BIG-IP Virtual Edition Intrusion Prevention System Add-on License for Advanced Firewall Manager 1 Gbps	F5-ADD-BIG-IPS-VE-1G
BIG-IP Virtual Edition Intrusion Prevention System Add-on License for Advanced Firewall Manager 200 Mbps	F5-ADD-BIG-IPSVE200M
BIG-IP Virtual Edition Intrusion Prevention System Add-on License for Advanced Firewall Manager 25 Mbps	F5-ADD-BIG-IPS-VE25M

Intrusion Prevention System (IPS) Signature Subscription Licenses for BIG-IP Virtual Edition

Description	Part Number
BIG-IP Intrusion Prevention System Signature License (1-Year Subscription, High Performance)	F5-SBS-BIGVE-IPS41YR
BIG-IP Intrusion Prevention System Signature License (3-Year Subscription, High Performance)	F5-SBS-BIGVE-IPS43YR
BIG-IP Intrusion Prevention System Signature License (1-Year Subscription, 10 Gbps)	F5-SBS-BIGVE-IPS31YR
BIG-IP Intrusion Prevention System Signature License (3-Year Subscription, 10 Gbps)	F5-SBS-BIGVE-IPS33YR
BIG-IP Intrusion Prevention System Signature License (1-Year Subscription, 1 Gbps, 3 Gbps, and 5 Gbps)	F5-SBS-BIGVE-IPS21YR
BIG-IP Intrusion Prevention System Signature License (3-Year Subscription, 1 Gbps, 3 Gbps, and 5 Gbps)	F5-SBS-BIGVE-IPS23YR
BIG-IP Intrusion Prevention System Signature License (1-Year Subscription, 25 Mbps and 200 Mbps)	F5-SBS-BIGVE-IPS11YR
BIG-IP Intrusion Prevention System Signature License (3-Year Subscription, 25 Mbps and 200 Mbps)	F5-SBS-BIGVE-IPS13YR

Intrusion Prevention System (IPS) Add-on Modules for BIG-IP iSeries

Description	Part Number
BIG-IP Intrusion Prevention System Add-on License for i15X00 Advanced Firewall Manager	F5-ADD-BIG-IPSI15XXX
BIG-IP Intrusion Prevention System Add-on License for i11X00 Advanced Firewall Manager	F5-ADD-BIG-IPSI11XXX
BIG-IP Intrusion Prevention System Add-on License for i10X00 Advanced Firewall Manager	F5-ADD-BIG-IPSI10XXX
BIG-IP Intrusion Prevention System Add-on License for i7X00 Advanced Firewall Manager	F5-ADD-BIG-IPS-I7XXX
BIG-IP Intrusion Prevention System Add-on License for i5X00 Advanced Firewall Manager	F5-ADD-BIG-IPS-I5XXX
BIG-IP Intrusion Prevention System Add-on License for i4X00 Advanced Firewall Manager	F5-ADD-BIG-IPS-I4XXX
BIG-IP Intrusion Prevention System Add-on License for i2X00 Advanced Firewall Manager	F5-ADD-BIG-IPS-I2XXX

Intrusion Prevention System (IPS) Signature Subscription Licenses for BIG-IP iSeries

Description	Part Number
BIG-IP Intrusion Prevention System Signature License for i15X00 (1-Year Subscription)	F5-SBS-BIG-IPS-4-1YR
BIG-IP Intrusion Prevention System Signature License for i15X00 (3-Year Subscription)	F5-SBS-BIG-IPS-4-3YR
BIG-IP Intrusion Prevention System Signature License for i11X00/i10X00 (1-Year Subscription)	F5-SBS-BIG-IPS-3-1YR
BIG-IP Intrusion Prevention System Signature License for i11X00/i10X00 (3-Year Subscription)	F5-SBS-BIG-IPS-3-3YR
BIG-IP Intrusion Prevention System Signature License for i7X00/i5X00 (1-Year Subscription)	F5-SBS-BIG-IPS-2-1YR
BIG-IP Intrusion Prevention System Signature License for i7X00/i5X00 (3-Year Subscription)	F5-SBS-BIG-IPS-2-3YR
BIG-IP Intrusion Prevention System Signature License for i4X00/i2X00 (1-Year Subscription)	F5-SBS-BIG-IPS-1-1YR
BIG-IP Intrusion Prevention System Signature License for i4X00/i2X00 (3-Year Subscription)	F5-SBS-BIG-IPS-1-3YR

Intrusion Prevention System (IPS) Add-on Licenses for VIPRION

Description	Part Number
VIPRION Intrusion Prevention System Add-on License for 4800 Chassis	F5-ADD-VPR-IPS-C4800
VIPRION Intrusion Prevention System Add-on License for 4480 Chassis	F5-ADD-VPR-IPS-C44X0
VIPRION Intrusion Prevention System Add-on License for 2X00 Chassis	F5-ADD-VPR-IPS-C2X00

Intrusion Prevention System (IPS) Signature Subscription Licenses for VIPRION

Description	Part Number
VIPRION Intrusion Prevention System Signature License for 4800 Chassis (1-Year Subscription)	F5-SBS-VPR-IPS-4-1YR
VIPRION Intrusion Prevention System Signature License for 4800 Chassis (3-Year Subscription)	F5-SBS-VPR-IPS-4-3YR
VIPRION Intrusion Prevention System Signature License for 4480 Chassis (1-Year Subscription)	F5-SBS-VPR-IPS-3-1YR
VIPRION Intrusion Prevention System Signature License for 4480 Chassis (3-Year Subscription)	F5-SBS-VPR-IPS-3-3YR
VIPRION Intrusion Prevention System Signature License for 2400 Chassis (1-Year Subscription)	F5-SBS-VPR-IPS-2-1YR
VIPRION Intrusion Prevention System Signature License for 2400 Chassis (3-Year Subscription)	F5-SBS-VPR-IPS-2-3YR
VIPRION Intrusion Prevention System Signature License for 2200 Chassis (1-Year Subscription)	F5-SBS-VPR-IPS-1-1YR
VIPRION Intrusion Prevention System Signature License for 2200 Chassis (3-Year Subscription)	F5-SBS-VPR-IPS-1-3YR

WEB FRAUD PROTECTION

WebSafe Bundle Subscription Licenses

Protect your business and customers from online fraud

WebSafe provides greater online fraud protection to prevent credential theft, malware, and phishing. WebSafe delivers web fraud protection that safeguards banks, e-retailers, and other organisations exposed to online fraud. It protects online customers from a broad range of web fraud across all devices – without impacting the user experience.

Key benefits

- Guard against targeted and generic malware
- Preempt phishing attacks
- Protect without client downloads
- Easily deploy fraud detection and prevention
- Maintain up-to-date global threat intelligence

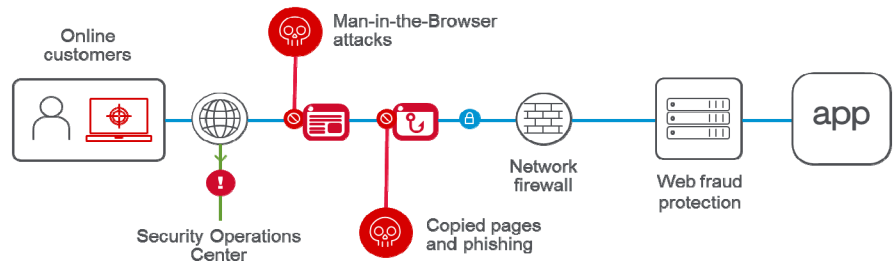

Description	Part Number
WebSafe Bundle License for 10000 Users (1-Year Subscription)	F5-SBS-WS-B-10K-1YR
WebSafe Bundle License for 50000 Users (1-Year Subscription)	F5-SBS-WS-B-50K-1YR
WebSafe Bundle License for 100000 Users (1-Year Subscription)	F5-SBS-WS-B-100K-1YR
WebSafe Bundle License for 500000 Users (1-Year Subscription, Consumer Only)	F5-SBS-WS-B-500K-1YR
WebSafe Bundle License for 1000000 Users (1-Year Subscription, Consumer Only)	F5-SBS-WS-B-1M-1YR
WebSafe Bundle License for 5000000 Users (1-Year Subscription, Consumer Only)	F5-SBS-WS-B-5M-1YR

Add-on Subscription Licenses for WebSafe

Description	Part Number
WebSafe Malware Detection License for 10000 Users (1-Year Subscription)	F5-SBS-WS-M-10K-1YR
WebSafe Malware Detection License for 50000 Users (1-Year Subscription)	F5-SBS-WS-M-50K-1YR
WebSafe Malware Detection License for 100000 Users (1-Year Subscription)	F5-SBS-WS-M-100K-1YR
WebSafe Malware Detection License for 500000 Users (1-Year Subscription, Consumer Only)	F5-SBS-WS-M-500K-1YR
WebSafe Malware Detection License for 1000000 Users (1-Year Subscription, Consumer Only)	F5-SBS-WS-M-1M-1YR
WebSafe Malware Detection License for 5000000 Users (1-Year Subscription, Consumer Only)	F5-SBS-WS-M-5M-1YR
WebSafe Anti Phishing License for 10000 Users (1-Year Subscription)	F5-SBS-WS-P-10K-1YR
WebSafe Anti Phishing License for 50000 Users (1-Year Subscription)	F5-SBS-WS-P-50K-1YR
WebSafe Anti Phishing License for 100000 Users (1-Year Subscription)	F5-SBS-WS-P-100K-1YR
WebSafe Anti Phishing License for 500000 Users (1-Year Subscription, Consumer Only)	F5-SBS-WS-P-500K-1YR
WebSafe Anti Phishing License for 1000000 Users (1-Year Subscription, Consumer Only)	F5-SBS-WS-P-1M-1YR
WebSafe Anti Phishing License for 5000000 Users (1-Year Subscription, Consumer Only)	F5-SBS-WS-P-5M-1YR
WebSafe Message Encryption License for 10000 Users (1-Year Subscription)	F5-SBS-WS-E-10K-1YR
WebSafe Message Encryption License for 50000 Users (1-Year Subscription)	F5-SBS-WS-E-50K-1YR
WebSafe Message Encryption License for 100000 Users (1-Year Subscription)	F5-SBS-WS-E-100K-1YR
WebSafe Message Encryption License for 500000 Users (1-Year Subscription, Consumer Only)	F5-SBS-WS-E-500K-1YR
WebSafe Message Encryption License for 1000000 Users (1-Year Subscription, Consumer Only)	F5-SBS-WS-E-1M-1YR
WebSafe Message Encryption License for 5000000 Users (1-Year Subscription, Consumer Only)	F5-SBS-WS-E-5M-1YR
WebSafe Auto Transaction Detection License for 10000 Users (1-Year Subscription)	F5-SBS-WS-T-10K-1YR
WebSafe Auto Transaction Detection License for 50000 Users (1-Year Subscription)	F5-SBS-WS-T-50K-1YR
WebSafe Auto Transaction Detection License for 100000 Users (1-Year Subscription)	F5-SBS-WS-T-100K-1YR
WebSafe Auto Transaction Detection License for 500000 Users (1-Year Subscription, Consumer Only)	F5-SBS-WS-T-500K-1YR
WebSafe Auto Transaction Detection License for 1000000 Users (1-Year Subscription, Consumer Only)	F5-SBS-WS-T-1M-1YR
WebSafe Auto Transaction Detection License for 5000000 Users (1-Year Subscription, Consumer Only)	F5-SBS-WS-T-5M-1YR

MobileSafe Subscription Licenses

Protect mobile device users from online fraud

MobileSafe helps you protect mobile device users from advanced cyber threats by delivering client-side safeguards that guard mobile application use in real-time – securing customer information and credentials, while helping to prevent identity theft and account takeovers.

Key benefits

- Minimise fraud loss associated with mobile device usage
- Improve mobile app protections
- Meet compliance standards
- Get 100% transparency and consumer coverage
- Drive immediate fraud response

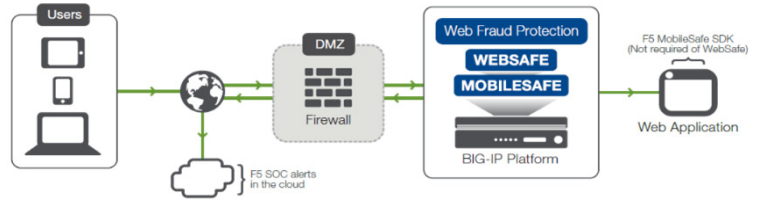

Description	Part Number
MobileSafe License for 10000 Users (1-Year Subscription)	F5-SBS-MS-10K-1YR
MobileSafe License for 50000 Users (1-Year Subscription)	F5-SBS-MS-50K-1YR
MobileSafe License for 100000 Users (1-Year Subscription)	F5-SBS-MS-100K-1YR
MobileSafe License for 500000 Users (1-Year Subscription, Consumer Only)	F5-SBS-MS-500K-1YR
MobileSafe License for 1000000 Users (1-Year Subscription, Consumer Only)	F5-SBS-MS-1M-1YR
MobileSafe License for 5000000 Users (1-Year Subscription, Consumer Only)	F5-SBS-MS-5M-1YR

Security Operations Center (SOC) Services

Description	Part Number
Security Operations Center Service (10 Shutdowns, Phishing Reports, Malware and Dropzone Research)	F5-SOC-10
Security Operations Center Service (50 Shutdowns, Phishing Reports, Malware and Dropzone Research)	F5-SOC-50
Security Operations Center Service (100 Shutdowns, Phishing Reports, Malware and Dropzone Research)	F5-SOC-100
Security Operations Center Service (200 Shutdowns, Phishing Reports, Malware and Dropzone Research)	F5-SOC-200
Security Operations Center Service (500 Shutdowns, Phishing Reports, Malware and Dropzone Research)	F5-SOC-500
Security Operations Center Service (800 Shutdowns, Phishing Reports, Malware and Dropzone Research)	F5-SOC-800
Security Operations Center Service Single Shutdown	F5-SOC-1

MANAGED WEB APPLICATION FIREWALL SERVICES

Full- and self-service, cloud-based security to protect your applications

Silverline Web Application Firewall (WAF) is a cloud-based managed service or express self-service that protects web applications and data from ever-evolving threats and enables compliance. Whether protecting apps on premises or in the cloud, Silverline WAF lets you augment your in-house resources and decrease operational expenses with a service that's wholly set up, deployed, and maintained by certified experts in F5's Security Operations Center.

Key benefits

- Ensure application security and compliance
- Get 24x7x365 WAF expert service
- Deploy flexibly across hybrid environments
- Defend with proven security effectiveness
- Drive operational and cost efficiencies
- Gain attack insights and intelligence

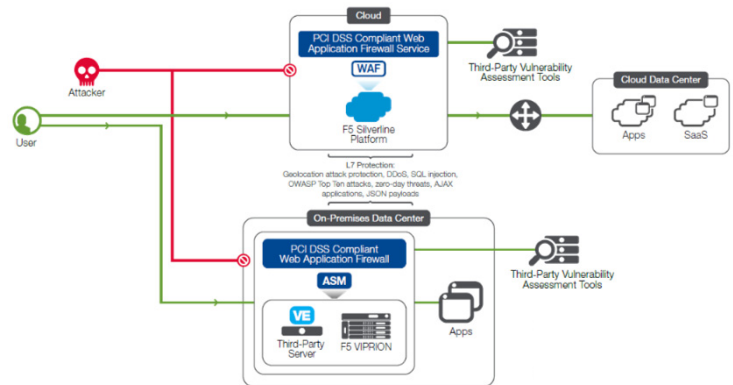

Silverline Web Application Firewall (WAF) Subscription Services

Description	Part Number
Silverline Web Application Firewall Managed Service (Base, 1-Month Subscription)	F5-FAS-WAF-MGND
Silverline Web Application Firewall Express Service (Base, 1-Month Subscription)	F5-FAS-WAF-EXP
Throughput for Silverline Web Application Firewall Service (Per 1 Mbps)	F5-FAS-WAF-TP
Fully Qualified Domain Name for Silverline Web Application Firewall Service (One FQDN, 1-Month Subscription)	F5-FAS-WAF-FQDN

MANAGED THREAT INTELLIGENCE SERVICES

Defend against malicious traffic

F5 Silverline Threat Intelligence is a cloud-based service incorporating external IP reputation and reducing threat-based communications. By identifying IP addresses and security categories associated with malicious activity, this managed service integrates dynamic lists of threatening IP addresses with the Silverline cloud-based platform, adding context-based security to policy decisions.

Key benefits

- Ensure IP threat protection
- Improve threat visibility
- Automate blocking and granular reporting
- Optimise real-time threat security

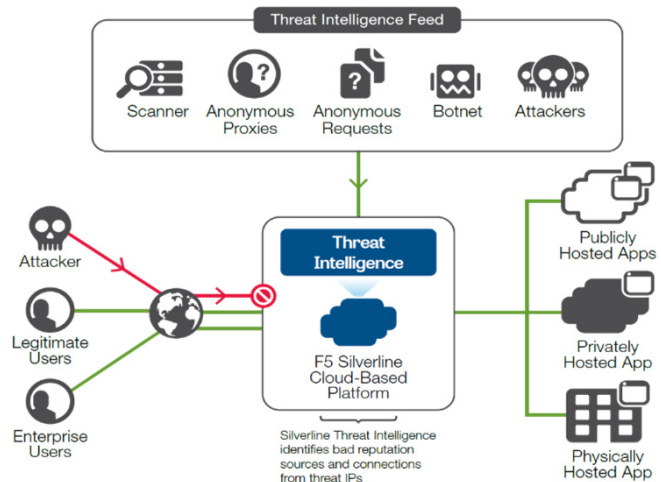

Silverline Threat Intelligence IP Reputation Subscription Services

Description	Part Number
Silverline Threat Intelligence IP Reputation Service (0-250 Mbps Clean Bandwidth, 1-Month Subscription)	F5-FAS-IP1-250M
Silverline Threat Intelligence IP Reputation Service (251 Mbps - 1 Gbps Clean Bandwidth, 1-Month Subscription)	F5-FAS-IP1-1G
Silverline Threat Intelligence IP Reputation Service (1 Gbps+ Clean Bandwidth, 1-Month Subscription)	F5-FAS-IP1-1GP

APPLICATION ACCESS

ACCESS POLICY MANAGER

Secure, simplify, and protect user access to applications and data

BIG-IP Access Policy Manager (APM) is a secure, flexible, high-performance solution that provides unified global access to your network, cloud, and applications. With a single management interface, it converges and consolidates remote, mobile, network, virtual desktops, and web access. BIG-IP APM enables the creation and enforcement of simple, easy-to-manage, intelligent access policies.

Key benefits

- Simplify access management with identity, context, and app-aware policies
- Provide authentication, authorisation, and endpoint inspection
- Consolidate remote, mobile, network, VDI, and web access in one
- Reduce costs by replacing proxy tiers with an integrated solution
- Scale and support up to 2M access sessions on a single chassis

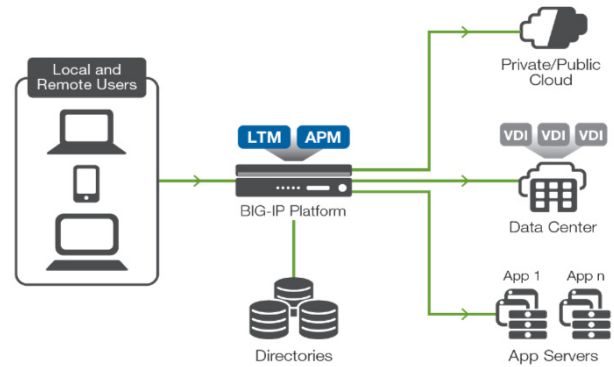

Access Policy Manager (APM) Licenses for BIG-IP Virtual Edition

Description	Part Number
BIG-IP Virtual Edition Access Policy Manager Base Add-on License (50 Concurrent VPN Users)	F5-ADD-BIG-APM-VEB
BIG-IP Virtual Edition Access Policy Manager License Upgrade (200 Mbps to 1 Gbps)	F5-ADD-BIG-APMVEUP1G
BIG-IP Virtual Edition Add-on License for Access Policy Manager (50 Concurrent VPN Users)	F5-ADD-BIG-VE-USER50
BIG-IP Virtual Edition Add-on License for Access Policy Manager (250 Concurrent VPN Users)	F5-ADD-BIGVE-USER250
BIG-IP Virtual Edition Add-on License for Access Policy Manager (1000 Concurrent VPN Users)	F5-ADD-BIGVE-USER1K
BIG-IP Virtual Edition Add-on License for Access Policy Manager (2500 Concurrent VPN Users)	F5-ADD-BIGVE-USR2500

BIG-IP iSeries Access Policy Manager (APM)

Description	Part Number
BIG-IP i15800 Access Policy Manager Max (512 GB Memory, SSD, Max SSL, Max Compression, vCMP, Dual AC Power Supplies)	F5-BIG-APM-I15800-M
BIG-IP i11800 Access Policy Manager Turbo SSL Max (256 GB Memory, Dual SSD, Max SSL, Max Compression, vCMP, Dual AC Power Supplies)	F5-BIG-APM-I11800DSM
BIG-IP i11800 Access Policy Manager Max (256 GB Memory, SSD, Max SSL, Max Compression, vCMP, Dual AC Power Supplies)	F5-BIG-APM-I11800-M
BIG-IP i10800 Access Policy Manager Max (128 GB Memory, Dual SSD, Max SSL, Max Compression, vCMP, Dual AC Power Supplies)	F5-BIG-APM-I10800-DM
BIG-IP i10800 Access Policy Manager Base (128 GB Memory, SSD, Max SSL, Max Compression, vCMP, Dual AC Power Supplies)	F5-BIG-APM-I10800-B
BIG-IP i7800 Access Policy Manager Max (96 GB Memory, Dual SSD, Max SSL, Max Compression, vCMP, Dual AC Power Supplies)	F5-BIG-APM-I7800-DM
BIG-IP i7800 Access Policy Manager Base (96 GB Memory, SSD, Max SSL, Max Compression, vCMP, Dual AC Power Supplies)	F5-BIG-APM-I7800-B
BIG-IP i5800 Access Policy Manager Max (48 GB Memory, SSD, Max SSL, Max Compression, vCMP)	F5-BIG-APM-I5800-M
BIG-IP i4800 Access Policy Manager Max (32 GB Memory, Max SSL, Max Compression)	F5-BIG-APM-I4800-M
BIG-IP i2800 Access Policy Manager Max (16 GB Memory, Max SSL, Max Compression)	F5-BIG-APM-I2800-M
BIG-IP i4600 Access Policy Manager Max (32 GB Memory, Base SSL, Base Compression)	F5-BIG-APM-I4600-M
BIG-IP i2600 Access Policy Manager Max (16 GB Memory, Base SSL, Base Compression)	F5-BIG-APM-I2600-M
BIG-IP i15800 Access Policy Manager Base (512 GB Memory, SSD, Max SSL, Max Compression, vCMP, Dual AC Power Supplies)	F5-BIG-APM-I15800-B
BIG-IP i11800 Access Policy Manager Turbo SSL Base (256 GB Memory, Dual SSD, Max SSL, Max Compression, vCMP, Dual AC Power Supplies)	F5-BIG-APM-I11800DSB
BIG-IP i11800 Access Policy Manager Base (256 GB Memory, SSD, Max SSL, Max Compression, vCMP, Dual AC Power Supplies)	F5-BIG-APM-I11800-B
BIG-IP i10800 Access Policy Manager Base (128 GB Memory, Dual SSD, Max SSL, Max Compression, vCMP, Dual AC Power Supplies)	F5-BIG-APM-I10800-DB
BIG-IP i10800 Access Policy Manager Base (128 GB Memory, SSD, Max SSL, Max Compression, vCMP, Dual AC Power Supplies)	F5-BIG-APM-I10800-B
BIG-IP i7800 Access Policy Manager Base (96 GB Memory, Dual SSD, Max SSL, Max Compression, vCMP, Dual AC Power Supplies)	F5-BIG-APM-I7800-DB
BIG-IP i7800 Access Policy Manager Base (96 GB Memory, SSD, Max SSL, Max Compression, vCMP, Dual AC Power Supplies)	F5-BIG-APM-I7800-B
BIG-IP i5800 Access Policy Manager Base (48 GB Memory, SSD, Max SSL, Max Compression, vCMP)	F5-BIG-APM-I5800-B
BIG-IP i4800 Access Policy Manager Base (32 GB Memory, Max SSL, Max Compression)	F5-BIG-APM-I4800-B
BIG-IP i2800 Access Policy Manager Base (16 GB Memory, Max SSL, Max Compression)	F5-BIG-APM-I2800-B
BIG-IP i4600 Access Policy Manager Base (32 GB Memory, Base SSL, Base Compression)	F5-BIG-APM-I4600-B
BIG-IP i2600 Access Policy Manager Base (16 GB Memory, Base SSL, Base Compression)	F5-BIG-APM-I2600-B
BIG-IP i7820 Access Policy Manager FIPS Max (96 GB Memory, Dual SSD, Hardware Security Module, Max SSL, Max Compression, vCMP, Dual AC Power Supplies)	F5-BIG-APM-I7820-DF-M
BIG-IP i7820 Access Policy Manager FIPS Base (96 GB Memory, Dual SSD, Hardware Security Module, Max SSL, Max Compression, vCMP, Dual AC Power Supplies)	F5-BIG-APM-I7820-DF-B

BIG-IP i5820 Access Policy Manager FIPS Max (48 GB Memory, Dual SSD, Hardware Security Module, Max SSL, Max Compression, vCMP)	F5-BIG-APM-I5820-DF-M
BIG-IP i5820 Access Policy Manager FIPS Base (48 GB Memory, Dual SSD, Hardware Security Module, Max SSL, Max Compression, vCMP)	F5-BIG-APM-I5820-DF-B
BIG-IP i15800 Access Policy Manager NEBS Max (512 GB Memory, SSD, Max SSL, Max Compression, vCMP, Dual DC Power Supplies, NEBS Level 3 Certified)	F5-BIG-APM-I15800-NM
BIG-IP i15800 Access Policy Manager NEBS Base (512 GB Memory, SSD, Max SSL, Max Compression, vCMP, Dual DC Power Supplies, NEBS Level 3 Certified)	F5-BIG-APM-I15800-NB

Access Policy Manager (APM) Add-on Modules for BIG-IP iSeries

Description	Part Number
BIG-IP Access Policy Manager Max Module for i15800	F5-ADD-BIGAPMI158XXM
BIG-IP Access Policy Manager Max Module for i11800	F5-ADD-BIGAPMI118XXM
BIG-IP Access Policy Manager Max Module for i10800	F5-ADD-BIGAPMI108XXM
BIG-IP Access Policy Manager Max Module for i7800	F5-ADD-BIG-APMI78XXM
BIG-IP Access Policy Manager Max Module for i5800	F5-ADD-BIG-APMI58XXM
BIG-IP Access Policy Manager Max Module for i4800	F5-ADD-BIG-APMI48XXM
BIG-IP Access Policy Manager Max Module for i2800	F5-ADD-BIG-APMI28XXM
BIG-IP Access Policy Manager Max Module for i15600	F5-ADD-BIGAPMI156XXM
BIG-IP Access Policy Manager Max Module for i11600	F5-ADD-BIGAPMI116XXM
BIG-IP Access Policy Manager Max Module for i11400	F5-ADD-BIGAPMI114XXM
BIG-IP Access Policy Manager Max Module for i10600	F5-ADD-BIGAPMI106XXM
BIG-IP Access Policy Manager Max Module for i7600	F5-ADD-BIG-APMI76XXM
BIG-IP Access Policy Manager Max Module for i5600	F5-ADD-BIG-APMI56XXM
BIG-IP Access Policy Manager Max Module for i4600	F5-ADD-BIG-APMI46XXM
BIG-IP Access Policy Manager Max Module for i2600	F5-ADD-BIG-APMI26XXM
BIG-IP Access Policy Manager Max Module for 10X5Xs (60000 Concurrent VPN Users)	F5-ADD-BIGAPM-10000S
BIG-IP Access Policy Manager Base Module for i15800	F5-ADD-BIG-APMI158XXB
BIG-IP Access Policy Manager Base Module for i11800	F5-ADD-BIGAPMI118XXB
BIG-IP Access Policy Manager Base Module for i10800	F5-ADD-BIGAPMI108XXB
BIG-IP Access Policy Manager Base Module for i7800	F5-ADD-BIG-APMI78XXB
BIG-IP Access Policy Manager Base Module for i5800	F5-ADD-BIG-APMI58XXB
BIG-IP Access Policy Manager Base Module for i4800	F5-ADD-BIG-APMI48XXB
BIG-IP Access Policy Manager Base Module for i2800	F5-ADD-BIG-APMI28XXB
BIG-IP Access Policy Manager Base Module for i15600	F5-ADD-BIGAPMI156XXB
BIG-IP Access Policy Manager Base Module for i11600	F5-ADD-BIGAPMI116XXB
BIG-IP Access Policy Manager Base Module for i11400	F5-ADD-BIGAPMI114XXB
BIG-IP Access Policy Manager Base Module for i10600	F5-ADD-BIGAPMI106XXB
BIG-IP Access Policy Manager Base Module for i7600	F5-ADD-BIG-APMI76XXB
BIG-IP Access Policy Manager Base Module for i5600	F5-ADD-BIG-APMI56XXB
BIG-IP Access Policy Manager Base Module for i4600	F5-ADD-BIG-APMI46XXB
BIG-IP Access Policy Manager Base Module for i2600	F5-ADD-BIG-APMI26XXB
BIG-IP Access Policy Manager Base Module for 10X5Xs (500 Concurrent VPN Users)	F5-ADDBIGAPM10000S-B
BIG-IP Max Access Sessions Add-on License for Access Policy Manager i15800	F5-ADDBIGAPMMXI158XX
BIG-IP Max Access Sessions Add-on License for Access Policy Manager i11800	F5-ADDBIGAPMMXI118XX
BIG-IP Max Access Sessions Add-on License for Access Policy Manager i10800	F5-ADDBIGAPMMXI108XX
BIG-IP Max Access Sessions Add-on License for Access Policy Manager i7800	F5-ADDBIGAPMMXI78XX
BIG-IP Max Access Sessions Add-on License for Access Policy Manager 10X5Xs (50000 Sessions)	F5-ADD-BIGAPMMX10000

Access Policy Manager (APM) Add-on User Licenses for BIG-IP iSeries

Description	Part Number
BIG-IP Add-on License for Access Policy Manager (10 Concurrent VPN Users)	F5-ADD-BIG-USER-10
BIG-IP Add-on License for Access Policy Manager (50 Concurrent VPN Users)	F5-ADD-BIG-USER-50
BIG-IP Add-on License for Access Policy Manager (100 Concurrent VPN Users)	F5-ADD-BIG-USER-100
BIG-IP Add-on License for Access Policy Manager (500 Concurrent VPN Users)	F5-ADD-BIG-USER-500
BIG-IP Add-on License for Access Policy Manager (1000 Concurrent VPN Users)	F5-ADD-BIG-USER-1K
BIG-IP Add-on License for Access Policy Manager (5000 Concurrent VPN Users)	F5-ADD-BIG-USER-5K
BIG-IP Add-on License for Access Policy Manager (10000 Concurrent VPN Users)	F5-ADD-BIG-USER-10K

Access Policy Manager (APM) Add-on Modules for VIPRION

Description	Part Number
VIPRION Access Policy Manager Max Module for 4800 Chassis (200000 Concurrent VPN Users)	F5-ADD-VPR-APM-C4800
VIPRION Access Policy Manager Max Module for 4480 Chassis (100000 Concurrent VPN Users)	F5-ADD-VPR-APM-C4400
VIPRION Access Policy Manager Base Module for 4800 Chassis (500 Concurrent VPN Users)	F5-ADD-VPRAPM-C4800B
VIPRION Access Policy Manager Base Module for 4480 Chassis (500 Concurrent VPN Users)	F5-ADD-VPRAPM-C4400B
VIPRION Access Policy Manager Max Module for 2400 Chassis (60000 Concurrent VPN Users)	F5-ADD-VPR-APM-C2400

VIPRION Access Policy Manager Max Module for 2200 Chassis (30000 Concurrent VPN Users)	F5-ADD-VPR-APM-C2200
VIPRION Access Policy Manager Base Module for 2400 Chassis (500 Concurrent VPN Users)	F5-ADD-VPRAPM-C2400B
VIPRION Access Policy Manager Base Module for 2200 Chassis (500 Concurrent VPN Users)	F5-ADD-VPRAPM-C2200B
VIPRION Max Access Sessions Add-on License for Access Policy Manager Module on 4800 Chassis (2000000 Sessions)	F5-ADD-VPRAPMMXC4800
VIPRION Max Access Sessions Add-on License for Access Policy Manager Module on 4480 Chassis (1000000 Sessions)	F5-ADD-VPRAPMMXC44X0
VIPRION Max Access Sessions Add-on License for Access Policy Manager Module on 2400 Chassis (500000 Sessions)	F5-ADD-VPRAPMMXC2400
VIPRION Max Access Sessions Add-on License for Access Policy Manager Module on 2200 Chassis (500000 Sessions)	F5-ADD-VPRAPMMXC2200

Access Policy Manager (APM) Add-on User Licenses for VIPRION

Description	Part Number
VIPRION Add-on License for Access Policy Manager (500 Concurrent VPN Users)	F5-ADD-VPR-USER-500
VIPRION Add-on License for Access Policy Manager (1000 Concurrent VPN Users)	F5-ADD-VPR-USER-1K
VIPRION Add-on License for Access Policy Manager (5000 Concurrent VPN Users)	F5-ADD-VPR-USER-5K
VIPRION Add-on License for Access Policy Manager (10000 Concurrent VPN Users)	F5-ADD-VPR-USER-10K
VIPRION Add-on License for Access Policy Manager (25000 Concurrent VPN Users)	F5-ADD-VPR-USER-25K

SECURE WEB GATEWAY

Gain insight and control over web traffic

BIG-IP Secure Web Gateway Services can enforce secure web access for on-premises, remote, and mobile users. It also helps protect against web-borne malware, targeted attacks, and other insidious dangers lurking on the web. Secure Web Gateway Services keeps your team connected without putting your network, applications, or data at risk.

Key benefits

- See who is visiting which sites and enable user-based web security policies
- Monitor and control off-premises or cloud-based user web activities
- Log web activity in forensic detail and publish it to leading SIEM solutions
- Use the web-based Splunk App to access aggregated graphical reports

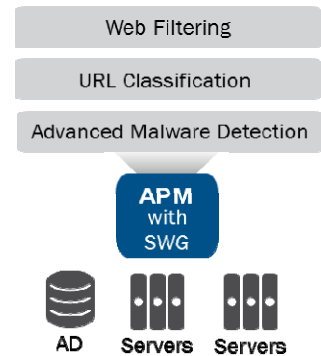

Secure Web Gateway Subscription Licenses for BIG-IP Virtual Edition

Description	Part Number
BIG-IP Virtual Edition Secure Web Gateway License (10000 Sessions, 1-Year Subscription, 3 Gbps / 5 Gbps / 10 Gbps)	F5-SBS-BIG-SWG-1C1YR
BIG-IP Virtual Edition Secure Web Gateway License (5000 Sessions, 1-Year Subscription, 3 Gbps / 5 Gbps / 10 Gbps)	F5-SBS-BIG-SWG-1B1YR
BIG-IP Virtual Edition Secure Web Gateway License (500 Sessions, 1-Year Subscription, 25 Mbps / 200 Mbps / 1 Gbps)	F5-SBS-BIG-SWG-1A1YR
BIG-IP Virtual Edition Secure Web Gateway License (10000 Sessions, 3-Year Subscription, 3 Gbps / 5 Gbps / 10 Gbps)	F5-SBS-BIG-SWG-1C3YR
BIG-IP Virtual Edition Secure Web Gateway License (5000 Sessions, 3-Year Subscription, 3 Gbps / 5 Gbps / 10 Gbps)	F5-SBS-BIG-SWG-1B3YR
BIG-IP Virtual Edition Secure Web Gateway License (500 Sessions, 3-Year Subscription, 25 Mbps / 200 Mbps / 1 Gbps)	F5-SBS-BIG-SWG-1A3YR

Secure Web Gateway (SWG) Subscription Licenses for BIG-IP iSeries

Description	Part Number
BIG-IP Secure Web Gateway License for i15X00 (100000 Sessions, 1-Year Subscription)	F5-SBS-BIG-SWG-101YM
BIG-IP Secure Web Gateway License for i15X00 (100000 Sessions, 3-Year Subscription)	F5-SBS-BIG-SWG-103YM
BIG-IP Secure Web Gateway License for i11X00 (100000 Sessions, 1-Year Subscription)	F5-SBS-BIG-SWG-9-1YM
BIG-IP Secure Web Gateway License for i11X00 (100000 Sessions, 3-Year Subscription)	F5-SBS-BIG-SWG-9-3YM
BIG-IP Secure Web Gateway Max License for 10X5Xs/i10X00 (50000 Sessions, 1-Year Subscription)	F5-SBS-BIG-SWG-8-1YM
BIG-IP Secure Web Gateway Max License for 10X5Xs/i10X00 (50000 Sessions, 3-Year Subscription)	F5-SBS-BIG-SWG-8-3YM
BIG-IP Secure Web Gateway Max License for i7X00 (40000 Sessions, 1-Year Subscription)	F5-SBS-BIG-SWG-7-1YM
BIG-IP Secure Web Gateway Max License for i7X00 (40000 Sessions, 3-Year Subscription)	F5-SBS-BIG-SWG-7-3YM
BIG-IP Secure Web Gateway License for i15X00 (50000 Sessions, 1-Year Subscription)	F5-SBS-BIG-SWG-101YR
BIG-IP Secure Web Gateway License for i15X00 (50000 Sessions, 3-Year Subscription)	F5-SBS-BIG-SWG-103YR
BIG-IP Secure Web Gateway License for i11X00 (50000 Sessions, 1-Year Subscription)	F5-SBS-BIG-SWG-9-1YR
BIG-IP Secure Web Gateway License for i11X00 (50000 Sessions, 3-Year Subscription)	F5-SBS-BIG-SWG-9-3YR
BIG-IP Secure Web Gateway License for 10X5Xs/i10X00 (1-Year Subscription)	F5-SBS-BIG-SWG-8-1YR
BIG-IP Secure Web Gateway License for 10X5Xs/i10X00 (3-Year Subscription)	F5-SBS-BIG-SWG-8-3YR
BIG-IP Secure Web Gateway License for i7X00 (1-Year Subscription)	F5-SBS-BIG-SWG-7-1YR
BIG-IP Secure Web Gateway License for i7X00 (3-Year Subscription)	F5-SBS-BIG-SWG-7-3YR
BIG-IP Secure Web Gateway License for i5X00 (1-Year Subscription)	F5-SBS-BIG-SWG-6-1YR
BIG-IP Secure Web Gateway License for i5X00 (3-Year Subscription)	F5-SBS-BIG-SWG-6-3YR
BIG-IP Secure Web Gateway License for i4X00 (1-Year Subscription)	F5-SBS-BIG-SWG-5-1YR
BIG-IP Secure Web Gateway License for i4X00 (3-Year Subscription)	F5-SBS-BIG-SWG-5-3YR
BIG-IP Secure Web Gateway License for i2800 (1-Year Subscription)	F5-SBS-BIG-SWG-3-1YR
BIG-IP Secure Web Gateway License for i2800 (3-Year Subscription)	F5-SBS-BIG-SWG-3-3YR
BIG-IP Secure Web Gateway License for i2600 (1-Year Subscription)	F5-SBS-BIG-SWG-2-1YR
BIG-IP Secure Web Gateway License for i2600 (3-Year Subscription)	F5-SBS-BIG-SWG-2-3YR

Secure Web Gateway (SWG) Subscription Licenses for VIPRION

Description	Part Number
VIPRION Secure Web Gateway License Max for 2X00 Chassis (60000 Sessions, 1-Year Subscription)	F5-SBS-VPR-SWG-1-1YM
VIPRION Secure Web Gateway License Max for 2X00 Chassis (60000 Sessions, 3-Year Subscription)	F5-SBS-VPR-SWG-1-3YM
VIPRION Secure Web Gateway License for 4800 Chassis (1-Year Subscription)	F5-SBS-VPR-SWG-3-1YR
VIPRION Secure Web Gateway License for 4800 Chassis (3-Year Subscription)	F5-SBS-VPR-SWG-3-3YR
VIPRION Secure Web Gateway License for 4480 Chassis (1-Year Subscription)	F5-SBS-VPR-SWG-2-1YR
VIPRION Secure Web Gateway License for 4480 Chassis (3-Year Subscription)	F5-SBS-VPR-SWG-2-3YR
VIPRION Secure Web Gateway License for 2X00 Chassis (1-Year Subscription)	F5-SBS-VPR-SWG-1-1YR
VIPRION Secure Web Gateway License for 2X00 Chassis (3-Year Subscription)	F5-SBS-VPR-SWG-1-3YR

URL FILTERING

Ensure appropriate usage policies

Using the extensive Forcepoint database, URL filtering in BIG-IP Secure Web Gateway Services controls access to websites, web-based applications, protocols, and videos. Secure Web Gateway Services also filters search results based on policy, preventing the display of offensive search results or images. URL filtering is customisable, and it helps reduce and mitigate corporate exposure to web-based threats and data leakage.

Category	Sub-Category	Filtering Action
Custom Categories		+
Abortion		+
Adult Material		-
	Nudity	-
	Sex	-
	Sex Education	+
	Lingerie and Swimsuit	-
	Adult Content	-
Advocacy Groups		+
Bandwidth		+
Business and Economy		+
Drugs		-
Education		+
Entertainment		+

URL Filtering Subscription Licenses for BIG-IP Virtual Edition

Description	Part Number
BIG-IP Virtual Edition URL Filtering License (20000 Sessions, 1-Year Subscription, High Performance)	F5-SBS-BIG-URL-1E1YR
BIG-IP Virtual Edition URL Filtering License (10000 Sessions, 1-Year Subscription, High Performance)	F5-SBS-BIG-URL-1D1YR
BIG-IP Virtual Edition URL Filtering License (10000 Sessions, 1-Year Subscription, 3 Gbps / 5 Gbps / 10 Gbps)	F5-SBS-BIG-URL-1C1YR
BIG-IP Virtual Edition URL Filtering License (5000 Sessions, 1-Year Subscription, 3 Gbps / 5 Gbps / 10 Gbps)	F5-SBS-BIG-URL-1B1YR
BIG-IP Virtual Edition URL Filtering License (500 Sessions, 1-Year Subscription, 25 Mbps / 200 Mbps / 1 Gbps)	F5-SBS-BIG-URL-1A1YR
BIG-IP Virtual Edition URL Filtering License (20000 Sessions, 3-Year Subscription, High Performance)	F5-SBS-BIG-URL-1E3YR
BIG-IP Virtual Edition URL Filtering License (10000 Sessions, 3-Year Subscription, High Performance)	F5-SBS-BIG-URL-1D3YR
BIG-IP Virtual Edition URL Filtering License (10000 Sessions, 3-Year Subscription, 3 Gbps / 5 Gbps / 10 Gbps)	F5-SBS-BIG-URL-1C3YR
BIG-IP Virtual Edition URL Filtering License (5000 Sessions, 3-Year Subscription, 3 Gbps / 5 Gbps / 10 Gbps)	F5-SBS-BIG-URL-1B3YR
BIG-IP Virtual Edition URL Filtering License (500 Sessions, 3-Year Subscription, 25 Mbps / 200 Mbps / 1 Gbps)	F5-SBS-BIG-URL-1A3YR

URL Filtering Subscription Licenses for BIG-IP iSeries

Description	Part Number
BIG-IP URL Filtering License for i15X00 (150000 Sessions, 1-Year Subscription)	F5-SBS-BIG-URL-101YM
BIG-IP URL Filtering License for i15X00 (150000 Sessions, 3-Year Subscription)	F5-SBS-BIG-URL-103YM
BIG-IP URL Filtering License for i11X00 (100000 Sessions, 1-Year Subscription)	F5-SBS-BIG-URL-9-1YM
BIG-IP URL Filtering License for i11X00 (100000 Sessions, 3-Year Subscription)	F5-SBS-BIG-URL-9-3YM
BIG-IP URL Filtering Max License for 10X5Xs/i10X00 (50000 Sessions, 1-Year Subscription)	F5-SBS-BIG-URL-8-1YM
BIG-IP URL Filtering Max License for 10X5Xs/i10X00 (50000 Sessions, 3-Year Subscription)	F5-SBS-BIG-URL-8-3YM
BIG-IP URL Filtering Max License for i7X00 (40000 Sessions, 1-Year Subscription)	F5-SBS-BIG-URL-7-1YM
BIG-IP URL Filtering Max License for i7X00 (40000 Sessions, 3-Year Subscription)	F5-SBS-BIG-URL-7-3YM
BIG-IP URL Filtering License for i15X00 (70000 Sessions, 1-Year Subscription)	F5-SBS-BIG-URL-101YR
BIG-IP URL Filtering License for i15X00 (70000 Sessions, 3-Year Subscription)	F5-SBS-BIG-URL-103YR
BIG-IP URL Filtering License for i11X00 (50000 Sessions, 1-Year Subscription)	F5-SBS-BIG-URL-9-1YR
BIG-IP URL Filtering License for i11X00 (50000 Sessions, 3-Year Subscription)	F5-SBS-BIG-URL-9-3YR
BIG-IP URL Filtering License for 10X5Xs/i10X00 (1-Year Subscription)	F5-SBS-BIG-URL-8-1YR
BIG-IP URL Filtering License for 10X5Xs/i10X00 (3-Year Subscription)	F5-SBS-BIG-URL-8-3YR
BIG-IP URL Filtering License for i7X00 (1-Year Subscription)	F5-SBS-BIG-URL-7-1YR
BIG-IP URL Filtering License for i7X00 (3-Year Subscription)	F5-SBS-BIG-URL-7-3YR
BIG-IP URL Filtering License for i5X00 (1-Year Subscription)	F5-SBS-BIG-URL-6-1YR
BIG-IP URL Filtering License for i5X00 (3-Year Subscription)	F5-SBS-BIG-URL-6-3YR
BIG-IP URL Filtering License for i4X00 (1-Year Subscription)	F5-SBS-BIG-URL-5-1YR
BIG-IP URL Filtering License for i4X00 (3-Year Subscription)	F5-SBS-BIG-URL-5-3YR
BIG-IP URL Filtering License for i2800 (1-Year Subscription)	F5-SBS-BIG-URL-3-1YR
BIG-IP URL Filtering License for i2800 (3-Year Subscription)	F5-SBS-BIG-URL-3-3YR
BIG-IP URL Filtering License for i2600 (1-Year Subscription)	F5-SBS-BIG-URL-2-1YR
BIG-IP URL Filtering License for i2600 (3-Year Subscription)	F5-SBS-BIG-URL-2-3YR

URL Filtering Subscription Licenses for VIPRION

Description	Part Number
VIPRION URL Filtering License Max for 2X00 Chassis (60000 Sessions, 1-Year Subscription)	F5-SBS-VPR-URL-1-1YM
VIPRION URL Filtering License Max for 2X00 Chassis (60000 Sessions, 3-Year Subscription)	F5-SBS-VPR-URL-1-3YM
VIPRION URL Filtering License for 4800 Chassis (1-Year Subscription)	F5-SBS-VPR-URL-3-1YR
VIPRION URL Filtering License for 4800 Chassis (3-Year Subscription)	F5-SBS-VPR-URL-3-3YR
VIPRION URL Filtering License for 4480 Chassis (1-Year Subscription)	F5-SBS-VPR-URL-2-1YR
VIPRION URL Filtering License for 4480 Chassis (3-Year Subscription)	F5-SBS-VPR-URL-2-3YR
VIPRION URL Filtering License for 2X00 Chassis (1-Year Subscription)	F5-SBS-VPR-URL-1-1YR
VIPRION URL Filtering License for 2X00 Chassis (3-Year Subscription)	F5-SBS-VPR-URL-1-3YR

INFRASTRUCTURE SECURITY

SSL ORCHESTRATOR

Provide visibility into SSL and TLS traffic at scale

F5 SSL Orchestrator maximises infrastructure investments, efficiencies, and security with dynamic, policy-based decryption, encryption, and traffic steering through multiple inspection devices. SSL Orchestrator applies context-based intelligence to allow you to manage the flow of encrypted traffic across your entire security chain. F5 partners with leading security companies, creating an ecosystem that strengthens security, increases scale and availability, and lowers operational costs for everyone.

Key benefits

- Enable visibility into SSL/TLS traffic
- Provide high-performance decryption of inbound and outbound SSL/TLS traffic
- Dynamically chain security devices
- Deliver a single platform for unified inspection
- Flexibly integrate into complex architectures
- Scale security services with high availability

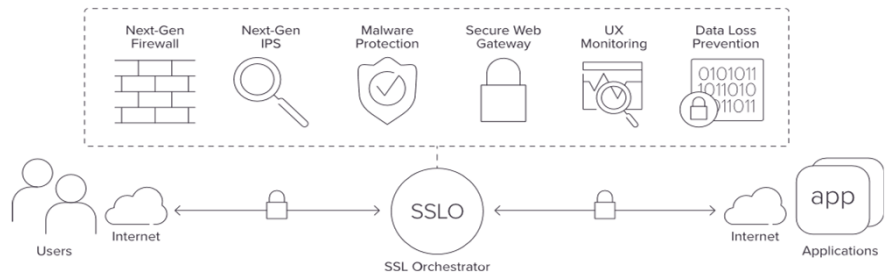

BIG-IP Virtual Edition SSL Orchestrator (SSLO)

Description	Part Number
BIG-IP Virtual Edition SSL Orchestrator High Performance (16 vCPUs, v14.x - v18.x)	F5-BIG-SSLO-VE-16V18
BIG-IP Virtual Edition SSL Orchestrator High Performance (8 vCPUs, v14.x - v18.x)	F5-BIG-SSLO-VE-08V18

SSL Orchestrator (SSLO) Add-on Licenses for BIG-IP Virtual Edition

Description	Part Number
BIG-IP Virtual Edition SSL Orchestrator Add-on License High Performance (4 vCPUs)	F5-ADD-BIG-SSLO-VE04
BIG-IP Virtual Edition SSL Orchestrator Add-on License 3 Gbps / 5 Gbps / 10 Gbps	F5-ADD-BIG-SSLO-VE-2
BIG-IP Virtual Edition SSL Orchestrator Add-on License 25 Mbps / 200 Mbps / 1 Gbps	F5-ADD-BIG-SSLO-VE-1

SSL and FIPS Add-On Licenses for BIG-IP Virtual Edition

Description	Part Number
BIG-IP Virtual Edition SSL and Compression Offload Add-on License (High Tier, per Intel QuickAssist Technology device)	F5-ADD-BIG-VE-SSL-H
BIG-IP Virtual Edition SSL and Compression Offload Add-on License (Medium Tier, per Intel QuickAssist Technology device)	F5-ADD-BIG-VE-SSL-M
BIG-IP Virtual Edition SSL and Compression Offload Add-on License (Low Tier, per Intel QuickAssist Technology device)	F5-ADD-BIG-VE-SSL-L
BIG-IP Virtual Edition FIPS Add-on License High Performance	F5-ADD-BIG-VE-F-4
BIG-IP Virtual Edition FIPS Add-on License 1 to 10 Gbps	F5-ADD-BIG-VE-F-3
BIG-IP Virtual Edition FIPS Add-on License 200 Mbps	F5-ADD-BIG-VE-F-2
BIG-IP Virtual Edition License for Network Hardware Security Module	F5-ADD-BIGEXT-HSM-VE

BIG-IP iSeries SSL Orchestrator (SSLO)

Description	Part Number
BIG-IP i15800 SSL Orchestrator (512 GB Memory, SSD, Max SSL, Max Compression, vCMP, Dual AC Power Supplies)	F5-BIG-SSLO-I15800
BIG-IP i11800 SSL Orchestrator (256 GB Memory, SSD, Max SSL, Max Compression, vCMP, Dual AC Power Supplies)	F5-BIG-SSLO-I11800
BIG-IP i10800 SSL Orchestrator (128 GB Memory, SSD, Max SSL, Max Compression, vCMP, Dual AC Power Supplies)	F5-BIG-SSLO-I10800
BIG-IP i5800 SSL Orchestrator (48 GB Memory, SSD, Max SSL, Max Compression, vCMP)	F5-BIG-SSLO-I5800
BIG-IP i2800 SSL Orchestrator (16 GB Memory, Max SSL, Max Compression)	F5-BIG-SSLO-I2800
BIG-IP i15800 SSL Orchestrator NEBS (512 GB Memory, SSD, Max SSL, Max Compression, vCMP, Dual AC Power Supplies, NEBS Level 3 Certified)	F5-BIG-SSLO-I15800-N

SSL Orchestrator (SSLO) Add-on Licenses for BIG-IP iSeries

Description	Part Number
BIG-IP SSL Orchestrator License for i15X00	F5-ADD-BIG-SSLO-5
BIG-IP SSL Orchestrator License for 10X5Xs/i1XX00	F5-ADD-BIG-SSLO-4
BIG-IP SSL Orchestrator License for i7XX0/i5XX0	F5-ADD-BIG-SSLO-3
BIG-IP SSL Orchestrator License for i4X00	F5-ADD-BIG-SSLO-2
BIG-IP SSL Orchestrator License for i2X00	F5-ADD-BIG-SSLO-1

SSL and FIPS Add-on Licenses for BIG-IP iSeries

Description	Part Number
BIG-IP License for Network Hardware Security Module	F5-ADD-BIG-EXT-HSM
BIG-IP Full-Box FIPS License for 10X5Xs	F5-ADD-BIG-FB-1
BIG-IP Full-Box FIPS License for i7X00/i5X00/i4X00	F5-ADD-BIG-FB-2

SSL Orchestrator (SSLO) Add-on Licenses for VIPRION

Description	Part Number
VIPRION SSL License Upgrade for 4800 Chassis (Max TPS)	F5-ADD-VPR-SSL8
VIPRION SSL License Upgrade for 4480/2400 Chassis (Max TPS)	F5-ADD-VPR-SSL4
VIPRION SSL License Upgrade for 2200 Chassis (Max TPS)	F5-ADD-VPR-SSL2
VIPRION Full-Box FIPS License for 2X00 Chassis	F5-ADD-VPR-FB-1
VIPRION Full-Box FIPS License for 4800/4480 Chassis	F5-ADD-VPR-FB-2

SSL Add-on Licenses for VIPRION

Description	Part Number
VIPRION Performance Extreme Add-on Module (Max SSL, Max Compression, Advanced Routing)	F5-ADD-VPR-PX
VIPRION License for Network Hardware Security Module	F5-ADD-VPR-EXT-HSM

ADVANCED FIREWALL MANAGER

Protect your network against incoming threats

BIG-IP Advanced Firewall Manager (AFM) mitigates network threats before they disrupt critical data center resources. BIG-IP AFM scales to shut down high-capacity DDoS attacks that can overwhelm firewalls and networks. It automatically invokes mitigation, alerts security admins, and configures or adjusts thresholds as traffic patterns change – without affecting legitimate traffic.

Key benefits

- Scale to meet network demand
- Ensure application availability
- Protect with app-centric, full-proxy firewall capabilities
- Inspect SSL sessions
- Streamline firewall deployment
- Customise reporting for visibility

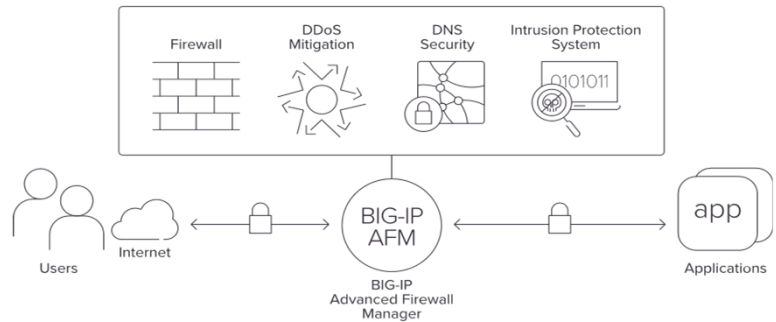

BIG-IP Virtual Edition Advanced Firewall Manager (AFM)

Description	Part Number
BIG-IP Virtual Edition Advanced Firewall Manager High Performance (8 vCPUs, v13.x - v18.x)	F5-BIG-AFM-VE-08-V18
BIG-IP Virtual Edition Advanced Firewall Manager 10 Gbps (v12.1.x - v18.x)	F5-BIG-AFM-VE-10GV18
BIG-IP Virtual Edition Advanced Firewall Manager 5 Gbps (v12.1.x - v18.x)	F5-BIG-AFM-VE-5G-V18
BIG-IP Virtual Edition Advanced Firewall Manager 3 Gbps (v12.1.x - v18.x)	F5-BIG-AFM-VE-3G-V18
BIG-IP Virtual Edition Advanced Firewall Manager 1 Gbps (v12.1.x - v18.x)	F5-BIG-AFM-VE-1G-V18
BIG-IP Virtual Edition Advanced Firewall Manager 200 Mbps (v12.1.x - v18.x)	F5-BIG-AFM-VE200MV18
BIG-IP Virtual Edition Advanced Firewall Manager 25 Mbps (v12.1.x - v18.x)	F5-BIG-AFM-VE-25MV18

Advanced Firewall Manager (AFM) Add-on Licenses for BIG-IP Virtual Edition

Description	Part Number
BIG-IP Virtual Edition Advanced Firewall Manager Add-on License High Performance (4 vCPUs)	F5-ADD-BIG-AFM-VE-04
BIG-IP Virtual Edition Advanced Firewall Manager License Upgrade (5 Gbps to 10 Gbps)	F5-ADD-BIGAFMVEUP10G
BIG-IP Virtual Edition Advanced Firewall Manager License Upgrade (3 Gbps to 5 Gbps)	F5-ADD-BIG-AFMVEUP5G
BIG-IP Virtual Edition Advanced Firewall Manager License Upgrade (1 Gbps to 3 Gbps)	F5-ADD-BIG-AFMVEUP3G
BIG-IP Virtual Edition Advanced Firewall Manager License Upgrade (200 Mbps to 1 Gbps)	F5-ADD-BIG-AFMVEUP1G
BIG-IP Virtual Edition Advanced Firewall Manager License Upgrade (25 Mbps to 200 Mbps)	F5-ADDBIGAFMVEUP200M

BIG-IP iSeries Advanced Firewall Manager (AFM)

Description	Part Number
BIG-IP i15800 Advanced Firewall Manager (512 GB Memory, SSD, Max SSL, Max Compression, Advanced Routing, vCMP, Dual AC Power Supplies)	F5-BIG-AFM-i15800
BIG-IP i11800 Advanced Firewall Manager Turbo SSL (256 GB Memory, Dual SSD, Max SSL, Max Compression, Advanced Routing, vCMP, Dual AC Power Supplies)	F5-BIG-AFM-i11800-DS
BIG-IP i11800 Advanced Firewall Manager (256 GB Memory, SSD, Max SSL, Max Compression, Advanced Routing, vCMP, Dual AC Power Supplies)	F5-BIG-AFM-i11800
BIG-IP i10800 Advanced Firewall Manager (128 GB Memory, Dual SSD, Max SSL, Max Compression, Advanced Routing, vCMP, Dual AC Power Supplies)	F5-BIG-AFM-i10800-D
BIG-IP i10800 Advanced Firewall Manager (128 GB Memory, SSD, Max SSL, Max Compression, Advanced Routing, vCMP, Dual AC Power Supplies)	F5-BIG-AFM-i10800
BIG-IP i7800 Advanced Firewall Manager (96 GB Memory, Dual SSD, Max SSL, Max Compression, Advanced Routing, vCMP, Dual AC Power Supplies)	F5-BIG-AFM-i7800-D
BIG-IP i7800 Advanced Firewall Manager (96 GB Memory, SSD, Max SSL, Max Compression, Advanced Routing, vCMP, Dual AC Power Supplies)	F5-BIG-AFM-i7800
BIG-IP i5800 Advanced Firewall Manager (48 GB Memory, SSD, Max SSL, Max Compression, Advanced Routing, vCMP)	F5-BIG-AFM-i5800
BIG-IP i4800 Advanced Firewall Manager (32 GB Memory, Max SSL, Max Compression, Advanced Routing)	F5-BIG-AFM-i4800
BIG-IP i2800 Advanced Firewall Manager (16 GB Memory, Max SSL, Max Compression, Advanced Routing)	F5-BIG-AFM-i2800
BIG-IP i15600 Advanced Firewall Manager (512 GB Memory, SSD, Base SSL, Base Compression, Advanced Routing, Dual AC Power Supplies)	F5-BIG-AFM-i15600
BIG-IP i11600 Advanced Firewall Manager Turbo SSL (256 GB Memory, Dual SSD, Base SSL, Base Compression, Advanced Routing, vCMP, Dual AC Power Supplies)	F5-BIG-AFM-i11600-DS

BIG-IP i11600 Advanced Firewall Manager (256 GB Memory, SSD, Base SSL, Base Compression, Advanced Routing, Dual AC Power Supplies)	F5-BIG-AFM-i11600
BIG-IP i11400 Advanced Firewall Manager Turbo SSL (256 GB Memory, Dual SSD, Base SSL, Base Compression, Advanced Routing, vCMP, Dual AC Power Supplies)	F5-BIG-AFM-i11400-DS
BIG-IP i10600 Advanced Firewall Manager (128 GB Memory, Dual SSD, Base SSL, Base Compression, Advanced Routing, Dual AC Power Supplies)	F5-BIG-AFM-i10600-D
BIG-IP i10600 Advanced Firewall Manager (128 GB Memory, SSD, Base SSL, Base Compression, Advanced Routing, Dual AC Power Supplies)	F5-BIG-AFM-i10600
BIG-IP i7600 Advanced Firewall Manager (96 GB Memory, Dual SSD, Base SSL, Base Compression, Advanced Routing, Dual AC Power Supplies)	F5-BIG-AFM-i7600-D
BIG-IP i7600 Advanced Firewall Manager (96 GB Memory, SSD, Base SSL, Base Compression, Advanced Routing, Dual AC Power Supplies)	F5-BIG-AFM-i7600
BIG-IP i5600 Advanced Firewall Manager (48 GB Memory, SSD, Base SSL, Base Compression, Advanced Routing)	F5-BIG-AFM-i5600
BIG-IP i4600 Advanced Firewall Manager (32 GB Memory, Base SSL, Base Compression, Advanced Routing)	F5-BIG-AFM-i4600
BIG-IP i2600 Advanced Firewall Manager (16 GB Memory, Base SSL, Base Compression, Advanced Routing)	F5-BIG-AFM-i2600
BIG-IP i15800 Advanced Firewall Manager NEBS (512 GB Memory, SSD, Max SSL, Max Compression, Advanced Routing, vCMP, Dual DC Power Supplies, NEBS Level 3 Certified)	F5-BIG-AFM-i15800-N
BIG-IP i15600 Advanced Firewall Manager NEBS (512 GB Memory, SSD, Base SSL, Base Compression, Advanced Routing, Dual DC Power Supplies, NEBS Level 3 Certified)	F5-BIG-AFM-i15600-N
BIG-IP 10150s Advanced Firewall Manager NEBS (128 GB Memory, SSD, Max SSL, Max Compression, Advanced Routing, Dual DC Power Supplies only, NEBS Level 3 Certified)	F5-BIG-AFM-10150S-N
BIG-IP 10350v Advanced Firewall Manager NEBS (128 GB Memory, SSD, Max SSL, Max Compression, Advanced Routing, vCMP, Dual DC Power Supplies only, NEBS Level 3 Certified)	F5-BIG-AFM-10350V-N

Advanced Firewall Manager (AFM) Add-on Modules for BIG-IP iSeries

Description	Part Number
BIG-IP Advanced Firewall Manager Module for i15X00	F5-ADD-BIG-AFMi15XXX
BIG-IP Advanced Firewall Manager Module for i11X00	F5-ADD-BIG-AFMi11XXX
BIG-IP Advanced Firewall Manager Module for i10X00	F5-ADD-BIG-AFMi10XXX
BIG-IP Advanced Firewall Manager Module for i7X00	F5-ADD-BIG-AFM-i7XXX
BIG-IP Advanced Firewall Manager Module for i5X00	F5-ADD-BIG-AFM-i5XXX
BIG-IP Advanced Firewall Manager Module for i4X00	F5-ADD-BIG-AFM-i4XXX
BIG-IP Advanced Firewall Manager Module for i2X00	F5-ADD-BIG-AFM-i2XXX
BIG-IP Advanced Firewall Manager Module for 10X5Xs	F5-ADD-BIG-AFM-10000

VIPRION Advanced Firewall Manager (AFM)

Description	Part Number
VIPRION 4800 Advanced Firewall Manager Chassis (8 x Slots, 2 x AC Power Supplies)	F5-VPR-AFM-C4800-AC
VIPRION 4480 Advanced Firewall Manager Chassis (4 x Slots, 4 x AC Power Supplies)	F5-VPR-AFM-C4480-AC
VIPRION 4800 Advanced Firewall Manager Chassis NEBS (8 x Slots, 2 x DC Power Supplies, NEBS Level 3 Certified)	F5-VPR-AFM-C4800-DCN
VIPRION 4480 Advanced Firewall Manager Chassis NEBS (4 x Slots, 4 x DC Power Supplies, NEBS Level 3 Certified)	F5-VPR-AFM-C4480-DCN
VIPRION 4450 Advanced Firewall Manager Blade NEBS (256 GB Memory, 6 x QSFP+ Ports, 2 x QSFP28 Ports, NEBS Level 3 Certified)	F5-VPR-AFM-B4450N
VIPRION 2400 Advanced Firewall Manager Chassis (4 x Slots, 2 x AC Power Supplies)	F5-VPR-AFM-C2400-AC
VIPRION 2200 Advanced Firewall Manager Chassis (2 x Slots, 2 x AC Power Supplies)	F5-VPR-AFM-C2200-AC
VIPRION 2200 Advanced Firewall Manager Chassis (2 x Slots, 2 x DC Power Supplies)	F5-VPR-AFM-C2200-DC
VIPRION 2250 Advanced Firewall Manager Blade (64 GB Memory, SSD, 4 x QSFP+ Ports)	F5-VPR-AFM-B2250

Advanced Firewall Manager (AFM) Add-on Modules for VIPRION

Description	Part Number
VIPRION Advanced Firewall Manager Module for 4800 Chassis (Max SSL)	F5-ADD-VPR-AFM-C4800
VIPRION Advanced Firewall Manager Module for 4480 Chassis (Max SSL)	F5-ADD-VPR-AFM-C4400
VIPRION Advanced Firewall Manager Module for 2X00 Chassis (Max SSL)	F5-ADD-VPR-AFM-C2400

CARRIER GRADE NAT

Stay ahead of the IPv4 to IPv6 migration

BIG-IP Carrier-Grade NAT (CGN) offers a broad set of tools that enables service providers to successfully migrate to IPv6 while continuing to support and interoperate with existing IPv4 devices and content. BIG-IP CGN offers service providers tunneling solutions with Dual-Stack Lite capabilities as well as native network address translation solutions, such as NAT44 and NAT64.

Key benefits

- Optimise network performance with carrier-grade performance and scalability
- Reduce servers and management costs
- Manage address depletion and IPv6 migration with flexible deployment options

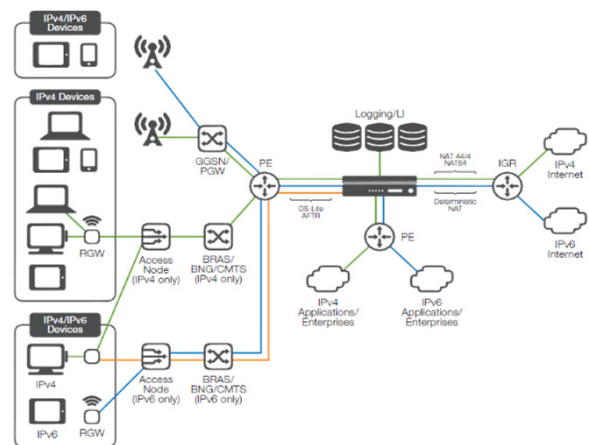

BIG-IP Virtual Edition Carrier Grade NAT (CGN)

Description	Part Number
BIG-IP Virtual Edition Carrier Grade NAT High Performance (8 vCPUs, v13.x - v18.x)	F5-BIG-CGN-VE-08-V18
BIG-IP Virtual Edition Carrier Grade NAT 10 Gbps (v12.1.x - v18.x)	F5-BIG-CGN-VE-10GV18
BIG-IP Virtual Edition Carrier Grade NAT 5 Gbps (v12.1.x - v18.x)	F5-BIG-CGN-VE-5G-V18
BIG-IP Virtual Edition Carrier Grade NAT 3 Gbps (v12.1.x - v18.x)	F5-BIG-CGN-VE-3G-V18
BIG-IP Virtual Edition Carrier Grade NAT 1 Gbps (v12.1.x - v18.x)	F5-BIG-CGN-VE-1G-V18
BIG-IP Virtual Edition Carrier Grade NAT 200 Mbps (v12.1.x - v18.x)	F5-BIG-CGN-VE200MV18
BIG-IP Virtual Edition Carrier Grade NAT 25 Mbps (v12.1.x - v18.x)	F5-BIG-CGN-VE-25MV18

Carrier Grade NAT (CGN) Add-on Licenses for BIG-IP Virtual Edition

Description	Part Number
BIG-IP Virtual Edition Carrier Grade NAT Add-on License High Performance (4 vCPUs)	F5-ADD-BIG-CGN-VE-04
BIG-IP Virtual Edition Carrier Grade NAT Add-on License 10 Gbps	F5-ADD-BIG-CGN-VE10G
BIG-IP Virtual Edition Carrier Grade NAT Add-on License 5 Gbps	F5-ADD-BIG-CGN-VE-5G
BIG-IP Virtual Edition Carrier Grade NAT Add-on License 3 Gbps	F5-ADD-BIG-CGN-VE-3G
BIG-IP Virtual Edition Carrier Grade NAT Add-on License 1 Gbps	F5-ADD-BIG-CGN-VE-1G
BIG-IP Virtual Edition Carrier Grade NAT Add-on License 200 Mbps	F5-ADD-BIG-CGNVE200M
BIG-IP Virtual Edition Carrier Grade NAT Add-on License 25 Mbps	F5-ADD-BIG-CGN-VE25M

BIG-IP iSeries Carrier Grade NAT (CGN)

Description	Part Number
BIG-IP i15800 Carrier Grade NAT (512 GB Memory, SSD, Dual AC Power Supplies)	F5-BIG-CGN-I15800
BIG-IP i11800 Carrier Grade NAT (256 GB Memory, SSD, Dual AC Power Supplies)	F5-BIG-CGN-I11800
BIG-IP i10800 Carrier Grade NAT (128 GB Memory, Dual SSD, Dual AC Power Supplies)	F5-BIG-CGN-I10800-D
BIG-IP i10800 Carrier Grade NAT (128 GB Memory, SSD, Dual AC Power Supplies)	F5-BIG-CGN-I10800
BIG-IP i7800 Carrier Grade NAT (96 GB Memory, Dual SSD, Dual AC Power Supplies)	F5-BIG-CGN-I7800-D
BIG-IP i7800 Carrier Grade NAT (96 GB Memory, SSD, Dual AC Power Supplies)	F5-BIG-CGN-I7800
BIG-IP i5800 Carrier Grade NAT (48 GB Memory, SSD)	F5-BIG-CGN-I5800
BIG-IP i4800 Carrier Grade NAT (32 GB Memory)	F5-BIG-CGN-I4800
BIG-IP i2800 Carrier Grade NAT (16 GB Memory)	F5-BIG-CGN-I2800
BIG-IP i15600 Carrier Grade NAT (512 GB Memory, SSD, Dual AC Power Supplies)	F5-BIG-CGN-I15600
BIG-IP i11600 Carrier Grade NAT (256 GB Memory, SSD, Dual AC Power Supplies)	F5-BIG-CGN-I11600
BIG-IP i10600 Carrier Grade NAT (128 GB Memory, Dual SSD, Dual AC Power Supplies)	F5-BIG-CGN-I10600-D
BIG-IP i10600 Carrier Grade NAT (128 GB Memory, SSD, Dual AC Power Supplies)	F5-BIG-CGN-I10600
BIG-IP i7600 Carrier Grade NAT (96 GB Memory, Dual SSD, Dual AC Power Supplies)	F5-BIG-CGN-I7600-D
BIG-IP i7600 Carrier Grade NAT (96 GB Memory, SSD, Dual AC Power Supplies)	F5-BIG-CGN-I7600
BIG-IP i5600 Carrier Grade NAT (48 GB Memory, SSD)	F5-BIG-CGN-I5600
BIG-IP i4600 Carrier Grade NAT (32 GB Memory)	F5-BIG-CGN-I4600
BIG-IP i2600 Carrier Grade NAT (16 GB Memory)	F5-BIG-CGN-I2600
BIG-IP i15800 Carrier Grade NAT NEBS (512 GB Memory, SSD, Dual DC Power Supplies, NEBS Level 3 Certified)	F5-BIG-CGN-I15800-N
BIG-IP i15600 Carrier Grade NAT NEBS (512 GB Memory, SSD, Dual AC Power Supplies, NEBS Level 3 Certified)	F5-BIG-CGN-I15600-N
BIG-IP 10350v Carrier Grade NAT NEBS (128 GB Memory, SSD, Dual DC Power Supplies only, NEBS Level 3 Certified)	F5-BIG-CGN-10350V-N
BIG-IP 10150s Carrier Grade NAT NEBS (128 GB Memory, SSD, Dual DC Power Supplies only, NEBS Level 3 Certified)	F5-BIG-CGN-10150S-N

Carrier Grade NAT (CGN) Add-on Modules for BIG-IP iSeries

Description	Part Number
BIG-IP Carrier Grade NAT Module for i15X00	F5-ADD-BIG-CGN115XXX
BIG-IP Carrier Grade NAT Module for i11X00	F5-ADD-BIG-CGN111XXX
BIG-IP Carrier Grade NAT Module for i10X00	F5-ADD-BIG-CGN110XXX
BIG-IP Carrier Grade NAT Module for i7X00	F5-ADD-BIG-CGN-I7XXX
BIG-IP Carrier Grade NAT Module for i5X00	F5-ADD-BIG-CGN-I5XXX
BIG-IP Carrier Grade NAT Module for i4X00	F5-ADD-BIG-CGN-I4XXX
BIG-IP Carrier Grade NAT Module for i2X00	F5-ADD-BIG-CGN-I2XXX
BIG-IP Carrier Grade NAT Module for 10X5Xs	F5-ADD-BIG-CGN-10000

VIPRION Carrier Grade NAT (CGN)

Description	Part Number
VIPRION 4800 Carrier Grade NAT Chassis (8 x Slots, 2 x AC Power Supplies)	F5-VPR-CGN-C4800-AC
VIPRION 4480 Carrier Grade NAT Chassis (4 x Slots, 4 x AC Power Supplies)	F5-VPR-CGN-C4480-AC
VIPRION 4800 Carrier Grade NAT Chassis NEBS (8 x Slots, 2 x DC Power Supplies, NEBS Level 3 Certified)	F5-VPR-CGN-C4800-DCN
VIPRION 4480 Carrier Grade NAT Chassis NEBS (4 x Slots, 4 x DC Power Supplies, NEBS Level 3 Certified)	F5-VPR-CGN-C4480-DCN
VIPRION 4450 Carrier Grade NAT Blade NEBS (256 GB Memory, 6 x QSFP+ Ports, 2 x QSFP28 Ports, NEBS Level 3 Certified)	F5-VPR-CGN-B4450N
VIPRION 2400 Carrier Grade NAT Chassis (4 x Slots, 2 x AC Power Supplies)	F5-VPR-CGN-C2400-AC
VIPRION 2200 Carrier Grade NAT Chassis (2 x Slots, 2 x AC Power Supplies)	F5-VPR-CGN-C2200-AC
VIPRION 2200 Carrier Grade NAT Chassis (2 x Slots, 2 x DC Power Supplies)	F5-VPR-CGN-C2200-DC
VIPRION 2250 Carrier Grade NAT Blade (64 GB Memory, SSD, 4 x QSFP+ Ports)	F5-VPR-CGN-B2250
VIPRION 2150 Carrier Grade NAT Blade (32 GB Memory, SSD, 8 x SFP+ Ports with 2 x 10GBASE-SR Transceivers included)	F5-VPR-CGN-B2150

Carrier Grade NAT (CGN) Add-on Modules for VIPRION

Description	Part Number
VIPRION Carrier Grade NAT Module	F5-ADD-VPR-CGN

DDoS HYBRID DEFENDER

Hybrid DDoS defence for the data center

F5 DDoS Hybrid Defender provides comprehensive DDoS protection for your network and at the application layer with flexibility and scale for inline, out-of-band, and hybrid deployments. DDoS Hybrid Defender is the only multi-layered defence that protects against blended network attacks and sophisticated application attacks, while enabling full SSL decryption, anti-bot capabilities, and advanced detection methods – all in one appliance.

Key benefits

- Stateful security, stateless scale
- Ultra-resilient hybrid design
- Operations speed
- Self-tuning and automated behavioural defence
- F5 security intelligence
- Deployment where you need it most

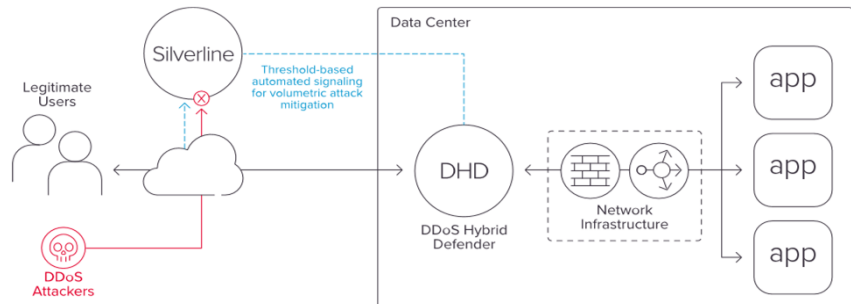

BIG-IP Virtual Edition DDoS Hybrid Defender (DHD)

Description	Part Number
BIG-IP Virtual Edition DDoS Hybrid Defender High Performance (8 vCPUs, v13.x - v18.x)	F5-BIG-DDOS-VE-08V18

DDoS Hybrid Defender (DHD) Add-on Licenses for BIG-IP Virtual Edition

Description	Part Number
BIG-IP Virtual Edition DDoS Hybrid Defender Add-on License High Performance (8 vCPUs)	F5-ADD-BIG-DDOS-VE-04

BIG-IP iSeries DDoS Hybrid Defender (DHD)

Description	Part Number
BIG-IP i15800 DDoS Hybrid Defender (512 GB Memory, SSD, Max SSL, Max Compression, vCMP, Dual AC Power Supplies)	F5-BIG-DDOS-I15800
BIG-IP i11800 DDoS Hybrid Defender (256 GB Memory, SSD, Max SSL, Max Compression, vCMP, Dual AC Power Supplies)	F5-BIG-DDOS-I11800
BIG-IP i10800 DDoS Hybrid Defender (128 GB Memory, SSD, Max SSL, Max Compression, vCMP, Dual AC Power Supplies)	F5-BIG-DDOS-I10800
BIG-IP i7800 DDoS Hybrid Defender (96 GB Memory, SSD, Max SSL, Max Compression, vCMP, Dual AC Power Supplies)	F5-BIG-DDOS-I7800
BIG-IP i5800 DDoS Hybrid Defender (48 GB Memory, SSD, Max SSL, Max Compression)	F5-BIG-DDOS-I5800
BIG-IP i15800 DDoS Hybrid Defender NEBS (512 GB Memory, SSD, Max SSL, Max Compression, vCMP, Dual DC Power Supplies, NEBS Level 3 Certified)	F5-BIG-DDOS-I15800-N

VIPRION DDoS Hybrid Defender (DHD)

Description	Part Number
VIPRION 4800 DDoS Hybrid Defender Chassis (8 x Slots, 2 x AC Power Supplies)	F5-VPR-DDOS-C4800-AC
VIPRION 4480 DDoS Hybrid Defender Chassis (4 x Slots, 4 x AC Power Supplies)	F5-VPR-DDOS-C4480-AC
VIPRION 4800 DDoS Hybrid Defender Chassis NEBS (8 x Slots, 2 x DC Power Supplies, NEBS Level 3 Certified)	F5-VPR-DDOS-C4800DCN
VIPRION 4480 DDoS Hybrid Defender Chassis NEBS (4 x Slots, 4 x DC Power Supplies, NEBS Level 3 Certified)	F5-VPR-DDOS-C4480DCN
VIPRION 4450 DDoS Hybrid Defender Blade NEBS (256 GB Memory, 6 x QSFP+ Ports, 2 x QSFP28 Ports, NEBS Level 3 Certified)	F5-VPR-DDOS-B4450N

MANAGED DDoS PROTECTION SERVICES

Cloud-delivered DDoS protection

Silverline DDoS Protection is a fully managed, cloud-delivered service that detects and mitigates large-scale, SSL, or application-targeted attacks in real time – defending your business from even those attacks that exceed hundreds of gigabits per second. Silverline reduces the burden on in-house security teams with cloud-based DDoS protections. It includes 24x7 access to experts from F5's Security Operations Center

Key benefits

- Keep business online during a DDoS attack
- Protect against all DDoS attack vectors
- Gain attack mitigation insights
- Defend against volumetric attacks
- Get expert service
- Drive efficiencies with hybrid DDoS solution

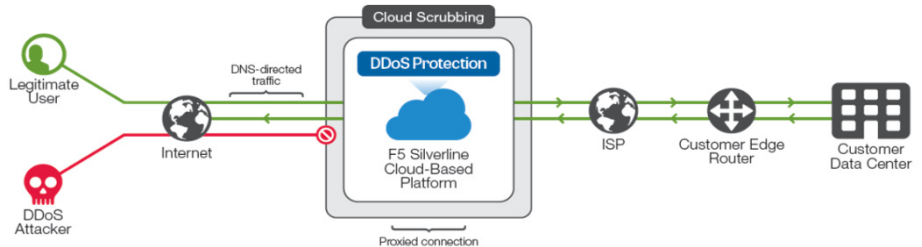

Silverline DDoS Protection Subscription Services

Description	Part Number
Silverline DDoS Protection Service Always On (Base, 1-Month Subscription)	F5-FAS-DOS-AO
Silverline DDoS Protection Service Always Available (Base, 1-Month Subscription)	F5-FAS-DOS-AA
Throughput for Silverline DDoS Protection Service Always On (Per 1 Mbps Clean Bandwidth)	F5-FAS-DOS-TPAO
Throughput for Silverline DDoS Protection Service Always Available (Per 1 Mbps Clean Bandwidth)	F5-FAS-DOS-TPAA

Additional Options for Silverline DDoS Protection Subscription Services

Description	Part Number
Additional Data Center for Silverline DDoS Protection Service (1-Month Subscription)	F5-FAS-DC
Additional Proxy Address for Silverline DDoS Protection Service (1-Month Subscription)	F5-FAS-IP
Router Monitoring for Silverline DDoS Protection Service (1-Month Subscription)	F5-FAS-RM
Silverline Security Operations Center Specialized Engineering Support (per hour)	F5-UTL-FEE-SOCS
Silverline Service Deployment Fee (standard hours)	F5-UTL-FEE-S
Silverline Service Deployment Fee (premium hours)	F5-UTL-FEE-P

AUTOMATION, ORCHESTRATION, AND MANAGEMENT

AUTOMATION TOOLCHAIN

Empower DevOps with automation tools

F5 Automation Toolchain is a set of automation tools that makes it faster and easier to deploy and configure application services. The toolchain allows services such as traffic management and application security to be managed programmatically, through simple, declarative APIs. F5 Automation Toolchain enables developers to programmatically extend F5 application services and integrate with CI/CD toolchains, orchestration systems, and 3rd-party ecosystems.

Key benefits

- Faster and easier deploy and configure F5 devices and application services
- Easily implement agile methodology with declarative model
- Integrate with 3rd-party automation and orchestration systems
- Monitor and analyse applications through BIG-IQ or Telemetry Streaming
- Manage application-specific configurations on BIG-IP

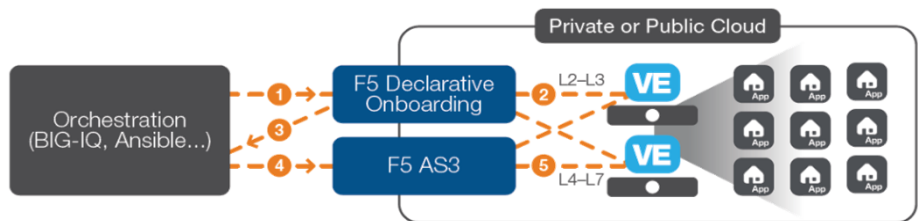

TECHNOLOGIES AND PROGRAMMABILITY

Technologies to deliver every app, anywhere

F5 technologies help deliver applications and data with greater agility, security, availability, performance, and scalability. F5 products and the platforms they run on ensure your apps are fast, secure, and available – anywhere on any device.

Key technologies

- **iApps**: Automating and saving time
- **iRules**: Custom scripting
- **iControl LX**: Programmable extensibility layer
- **iControl REST**: Integration at your fingertips
- **iCall**: Device configuration
- **iHealth**: Diagnostic tool for BIG-IP

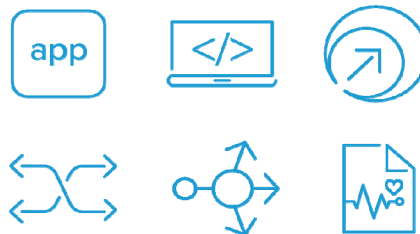

CONTAINER INGRESS SERVICES

Deploy faster with self-service and automated app scale and security

F5 Container Ingress Services makes it easy to deliver advanced application services to your container deployments, enabling ingress control HTTP routing, load balancing, and application delivery performance, as well as robust security services. Container Ingress Services easily integrates BIG-IP solutions with native container environments, such as Kubernetes, and PaaS container orchestration and management systems, such as Red Hat OpenShift.

Key benefits

- Dynamic application services for PaaS and containers
- Self-service selection and automated event discovery
- Scalability and security with app services insertion
- Faster deployment and end-to-end visibility

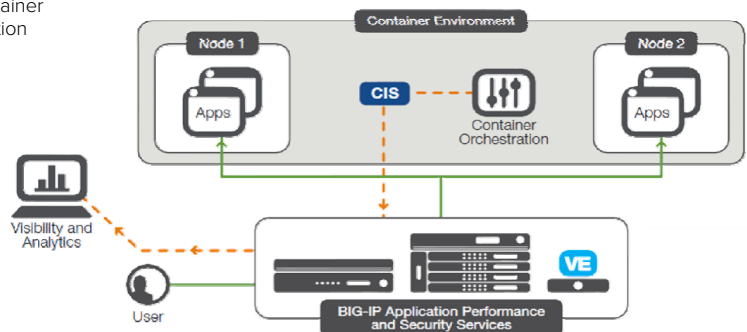

CENTRALISED MANAGEMENT

Application-centric management

BIG-IQ Centralized Management provides a central point of control for F5 physical and virtual devices. It simplifies management, helps ensure compliance, and gives you the tools you need to deliver your applications securely and effectively. BIG-IQ tracks assets, manages policies, delivers analytics, and provides central reporting and licensing for F5 products.

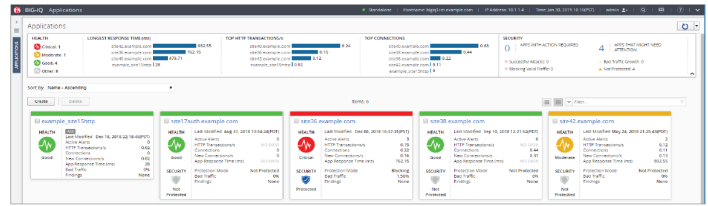

BIG-IQ Virtual Edition Centralized Manager

Description	Part Number
BIG-IQ Virtual Edition Centralized Manager (Max BIG-IP Instances)	F5-BIQ-VE-MAX
BIG-IQ Virtual Edition Centralized Manager (100 BIG-IP Instances)	F5-BIQ-VE-M
BIG-IQ Virtual Edition Centralized Manager (30 BIG-IP Instances)	F5-BIQ-VE-S
BIG-IQ Virtual Edition Centralized Manager (5 BIG-IP Instances)	F5-BIQ-VE-XS
BIG-IQ Virtual Edition Add-on License for Max BIG-IP Instances	F5-ADD-BIQ-VE-MAX
BIG-IQ Virtual Edition Add-on License for 20 BIG-IP Instances	F5-ADD-BIQ-VE-20
BIG-IQ Virtual Edition Lab License (Full Management for 2 Devices, License Management for 25 Devices)	F5-BIQ-VE-LAB
BIG-IQ Virtual Edition Lab Add-on License (License Management for 25 Devices)	F5-ADD-BIQ-LAB-25

BIG-IQ Cloud Edition Centralized Manager

Automatically deploy pre-built app services

While BIG-IQ provides single pane-of-glass management of all your F5 solutions, it also delivers application-specific management. BIG-IQ and BIG-IP Per-App Virtual Editions used together form BIG-IP Cloud Edition, a solution for enabling DevOps and application developers to manage network services for their own applications.

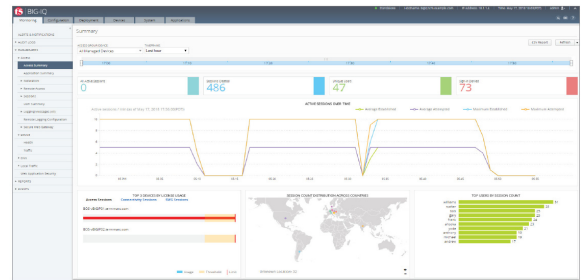

Description	Part Number
BIG-IQ Cloud Edition Centralized Manager (Max BIG-IP Cloud Edition Instances)	F5-BIQ-CE-MAX
BIG-IQ Centralized Manager Data Collection Device	F5-BIQ-VE-LOG-NODE

BIG-IQ 7000 Centralized Manager

Description	Part Number
BIG-IQ 7000 Centralized Manager (Max BIG-IP Instances)	F5-BIQ-7000-MAX
BIG-IQ 7000 Centralized Manager (100 BIG-IP Instances)	F5-BIQ-7000-M
BIG-IQ 7000 Centralized Manager (30 BIG-IP Instances)	F5-BIQ-7000-S
BIG-IQ 7000 Centralized Manager (5 BIG-IP Instances)	F5-BIQ-7000-XS
BIG-IQ 7000 Add-on License for Max BIG-IP Instances	F5-ADD-BIQ-7000-MAX
BIG-IQ 7000 Add-on License for 20 BIG-IP Instances	F5-ADD-BIQ-7000-20

NGINX Controller

Mission control for your applications

NGINX Controller is NGINX’s control-plane solution that manages the NGINX data plane. Built on a modular architecture, NGINX Controller enables you to manage the entire lifecycle of NGINX Plus, whether it’s deployed as a load balancer, API gateway, or a proxy in a service mesh environment. The Load Balancing Module configures, validates, and troubleshoots your load balancers. The API Management Module allows you to define, publish, secure, monitor, analyse APIs.

Key benefits

- Effortlessly manage load balancers, API gateways, and service mesh deployments at scale
- Ensure application performance, reliability, and availability
- Deploy new features and applications faster using a policy-driven approach
- Easily monitor and manage multiple NGINX Plus instances across multi-cloud environments

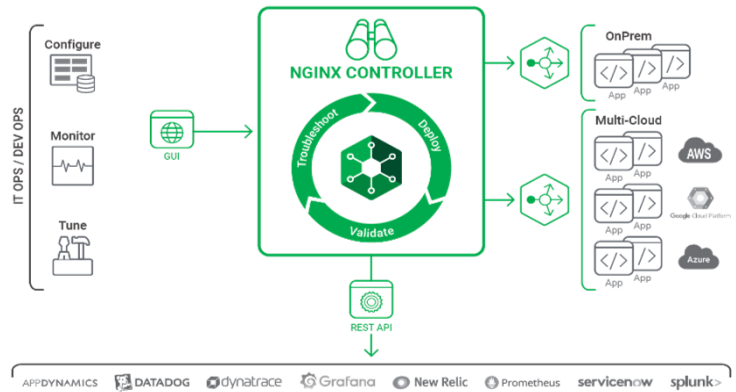

Description

For ordering information, see the NGINX website or contact your F5 representative.

Part Number

N/A

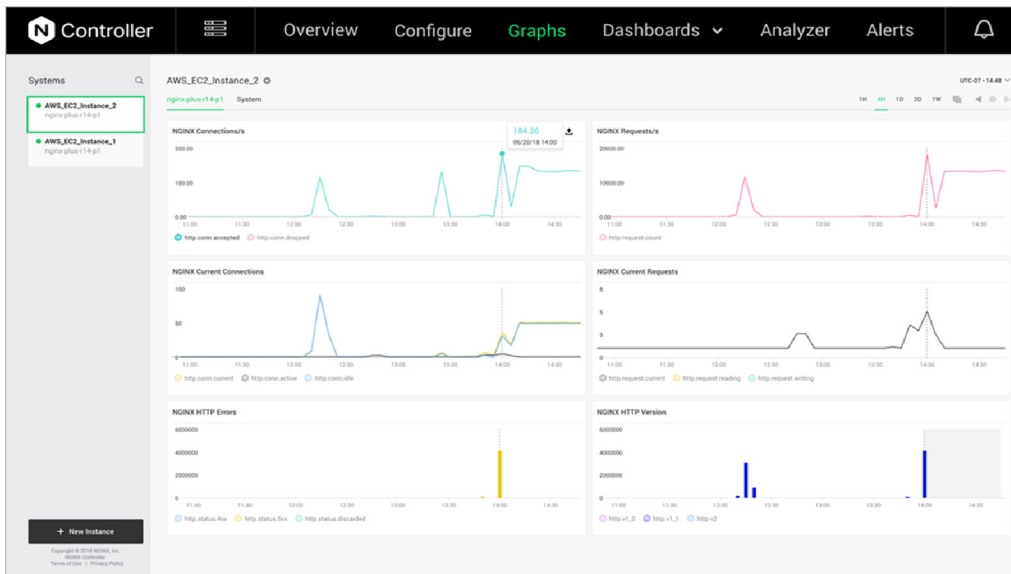

GLOBAL SERVICES

From downloads to training to community discussions

F5 Global Services offers world-class support, training, and consulting to help you get the most from your F5 investment. Whether it's providing fast answers to questions, training internal teams, or handling entire implementations from design to deployment, F5 Global Services can help ensure your applications are always secure, fast, and reliable.

SUPPORT SERVICES

Global reach, local touch

F5 Network Support Centers are strategically located for partners and customers and regionally located support centers enable F5 to provide support in a number of languages through native-speaking support engineers. Support options include business day response centers, premium around-the-clock access, or a dedicated support team assigned to your account. The AskF5 Knowledge Base houses product guides, release notes, solutions to known issues, how-to and hotfix information, downloads, and more.

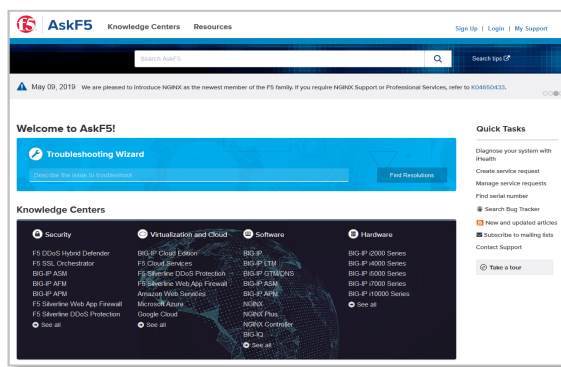

Support Services for Application Services Products

Description	Part Number
Level 1-3 Premium Service for BIG-IP (7x24)	F5-SVC-BIG-PRE-L1-3
Level 1-3 Standard Service for BIG-IP (5x10)	F5-SVC-BIG-STD-L1-3
Level 1-3 Premium Service for BIG-IP Virtual Edition (7x24) (VersionPlus only)	F5-SVC-BIG-VE+PREL13
Level 1-3 Standard Service for BIG-IP Virtual Edition (5x10) (VersionPlus only)	F5-SVC-BIG-VE+STD13
Level 1-3 Premium Service for BIG-IP Virtual Edition (7x24)	F5-SVC-BIG-VE-PREL13
Level 1-3 Standard Service for BIG-IP Virtual Edition (5x10)	F5-SVC-BIG-VE-STD13
Level 1-3 Premium Service for VIPRION (7x24)	F5-SVC-VPR-PRE-L1-3
Four-Hour Hardware Replacement Service (RMA) for BIG-IP (on-site technician)	F5-SVC-BIG-RMA-4-E
Four-Hour Hardware Replacement Service (RMA) for BIG-IP	F5-SVC-BIG-RMA-3
Next-Business-Day Hardware Replacement Service (RMA) for BIG-IP	F5-SVC-BIG-RMA-2
Four-Hour Hardware Replacement Service (RMA) for VIPRION (on-site technician)	F5-SVC-VPR-RMA-4-E
Four-Hour Hardware Replacement Service (RMA) for VIPRION	F5-SVC-VPR-RMA-3
Next-Business-Day Hardware Replacement Service (RMA) for VIPRION	F5-SVC-VPR-RMA-2

Support Services for Management Products

Description	Part Number
Level 1-3 Premium Service for Enterprise Manager (7x24)	F5-SVC-EM-PRE-L1-3
Level 1-3 Standard Service for Enterprise Manager (5x10)	F5-SVC-EM-STD-L1-3
Four-Hour Hardware Replacement Service (RMA) for Enterprise Manager (on-site technician)	F5-SVC-EM-RMA-4-E
Four-Hour Hardware Replacement Service (RMA) for Enterprise Manager	F5-SVC-EM-RMA-3
Next-Business-Day Hardware Replacement Service (RMA) for Enterprise Manager	F5-SVC-EM-RMA-2
Level 1-3 Premium Service for Enterprise Manager Virtual Edition (7x24)	F5-SVC-EM-VE-PREL13
Level 1-3 Standard Service for Enterprise Manager Virtual Edition (5x10)	F5-SVC-EM-VE-STD13
Level 1-3 Premium Service for BIG-IQ (7x24)	F5-SVC-BIQ-PRE-L1-3
Level 1-3 Standard Service for BIG-IQ (5x10)	F5-SVC-BIQ-STD-L1-3
Four-Hour Hardware Replacement Service (RMA) for BIG-IQ (on-site technician)	F5-SVC-BIQ-RMA-4-E
Four-Hour Hardware Replacement Service (RMA) for BIG-IQ	F5-SVC-BIQ-RMA-3
Next-Business-Day Hardware Replacement Service (RMA) for BIG-IQ	F5-SVC-BIQ-RMA-2
Level 1-3 Premium Service for BIG-IQ Virtual Edition (7x24)	F5-SVC-BIQ-VE-PREL13
Level 1-3 Standard Service for BIG-IQ Virtual Edition (5x10)	F5-SVC-BIQ-VE-STD13

Support Services for Service Provider Products

Description	Part Number
BIG-IP Essential Technical Services for Service Providers	F5-SVC-BIG-SPE
BIG-IP Virtual Edition Essential Technical Services for Service Providers	F5-SVC-BIG-VE-SPE

VIPRION Essential Technical Services for Service Providers	F5-SVC-VPR-SPE
BIG-IQ Essential Technical Services for Service Providers	F5-SVC-BIQ-SPE
BIG-IQ Virtual Edition Essential Technical Services for Service Providers	F5-SVC-BIQ-VE-SPE

Service and Support Fees

Description	Part Number
Administration Fee for Service Contract Detail Changes	F5-SVC-ADMIN-FEE
Lapsed Service Fee	F5-SVC-LAPSED-FEE
Recertification Fee	F5-CST-CERT
Setup and Migration Service Fee	F5-SVC-SM-FEE
No-Fault Service Fee	F5-SVC-NF-FEE
Admin Failure Service Fee	F5-SVC-AF-FEE
RMA Removable Hard Drive and Compact Flash Card Fee (per unit)	F5-SVC-RMA-OPT
Hardware Retention Service with Four-Hour Hardware Replacement Service (RMA)	F5-SVC-RMA-3-HWR
Hardware Retention Service with Next-Business-Day Hardware Replacement Service (RMA)	F5-SVC-RMA-2-HWR
BIG-IP iSeries Cloud-Ready Offer	F5-SVC-ISRS-CLD-OFR
VIPRION Cloud-Ready Offer	F5-SVC-VPR-CLD-OFR

PROFESSIONAL SERVICES

The services you need, when and how you need them

F5 Professional Services provides a full range of consulting services to support you throughout the entire lifecycle of your F5 solution deployment. Our experts can help you architect, implement, maintain, and optimise your solutions to support current and future business initiatives.

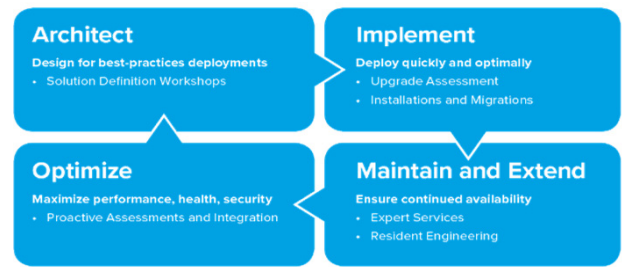

Implementation Services

Description	Part Number
Installation VIPRION Local Traffic Manager (per pair, standard hours)	F5-INST-VPRLTM
Installation VIPRION DNS (per pair, standard hours)	F5-INST-VPRLDNS
Installation VIPRION Advanced Web Application Firewall (per pair, standard hours)	F5-INST-VPRLAWF
Installation VIPRION Application Security Manager (per pair, standard hours)	F5-INST-VPRLASM
Installation BIG-IP Local Traffic Manager (per pair, standard hours)	F5-INST-BIGLTM
Installation BIG-IP Virtual Clustered Multiprocessing (2 hosts and 1 vCMP guest per pair, standard hours)	F5-INST-BIGVCMP1
Installation BIG-IP Cloud Edition	F5-INST-BIGCE
Installation BIG-IP DNS (per pair, standard hours)	F5-INST-BIGDNS
Installation BIG-IP Link Controller (per pair, standard hours)	F5-INST-BIGLC
Installation BIG-IP Advanced Web Application Firewall (per pair, standard hours)	F5-INST-BIGAWF
Installation BIG-IP Application Security Manager (per pair, standard hours)	F5-INST-BIGASM
Installation BIG-IP DDoS Hybrid Defender (per pair, standard hours)	F5-INST-BIGDDOS
Installation BIG-IP Access Policy Manager (per pair, standard hours)	F5-INST-BIGAPM

Consulting Services Packages

Description	Part Number
BIG-IP Local Traffic Manager Migration Service Package (per pair)	F5-CST-PKG-IMPL-03A
Proactive Assessment Service Package (per pair)	F5-CST-PKG-OPTM-02A
BIG-IP Advanced Firewall Manager Basic Implementation Service (per pair)	F5-CST-PKG-IMPL-04A
BIG-IP Advanced Firewall Manager Application Security Implementation Service (per pair)	F5-CST-PKG-IMPL-04B
BIG-IP Advanced Firewall Manager Migration Service (per pair)	F5-CST-PKG-IMPL-04C
BIG-IP Advanced Firewall Manager Application Security Migration Service (per pair)	F5-CST-PKG-IMPL-04D
F5 Virtual Desktop Deployment Service	F5-CST-PKG-IMPL-05A
On-site Solution Definition Workshop	F5-CST-PKG-SDW
Project Definition Workshop	F5-CST-PKG-PDW
Registered iRule Consulting Service 1-50	F5-CST-PKG-IRULE-01D
Registered iRule Consulting Service 51-200	F5-CST-PKG-IRULE-01E
Registered iRule Consulting Service 200+	F5-CST-PKG-IRULE-01F

Consulting Services per Hour and per Day

Description	Part Number
Standard Consulting (per hour, standard hours)	F5-CST-S
Premium Consulting (per hour, premium hours)	F5-CST-P
Standard Consulting (per hour, standard hours, prepaid)	F5-CST-S1
Premium Consulting (per hour, premium hours, prepaid)	F5-CST-P1
Standard Consulting Expert (per hour, standard hours)	F5-CST-ES
Premium Consulting Expert (per hour, premium hours)	F5-CST-EP
Standard Consulting Expert (per hour, standard hours, prepaid)	F5-CST-ES1
Premium Consulting Expert (per hour, premium hours, prepaid)	F5-CST-EP1
Consulting Project Manager (per hour)	F5-CST-PM
Consulting Project Manager (per hour, prepaid)	F5-CST-PM1
Consulting Travel Time (per hour)	F5-CST-T
Consulting Travel & Expenses 1	F5-CST-TE-1
Consulting Travel & Expenses 2	F5-CST-TE-2
Standard Daily Consulting (standard hours, max 8 hours)	F5-CST-S-DAY
Standard Daily Consulting Prepaid (standard hours, max 8 hours)	F5-CST-S-DAY1
Expert Standard Daily Consulting (standard hours, max 8 hours)	F5-CST-ES-DAY
Expert Standard Daily Consulting Prepaid (standard hours, max 8 hours)	F5-CST-ES-DAY1
Premium After Hours Consulting (premium hours, max 4 hours)	F5-CST-P-AH4
Premium After Hours Consulting Prepaid (premium hours, max 4 hours)	F5-CST-P-AH4-1

Expert Premium After Hours Consulting (premium hours, max 4 hours)	F5-CST-EP-AH4
Expert Premium After Hours Consulting Prepaid (premium hours, max 4 hours)	F5-CST-EP-AH4-1

Additional Consulting Services

Description	Part Number
Operational and Strategic Implementation Services (20)	F5-CST-OASIS-1
Operational and Strategic Implementation Services (55)	F5-CST-OASIS-2
Operational and Strategic Implementation Services (90)	F5-CST-OASIS-3
Operational and Strategic Implementation Services (130)	F5-CST-OASIS-4
Operational and Strategic Implementation Services (300)	F5-CST-OASIS-5
TCP Optimization Service for Communications Service Providers (per pair, standard hours)	F5-CST-OPTM-TCP-CSP1
TCP Optimization Service for Enterprises (per pair, standard hours)	F5-CST-OPTM-TCP-ENT1
DNS Protection and Acceleration Service (per pair, standard hours)	F5-CST-OPTM-DNS-PNA
DNS Parental Control Service (per pair, standard hours)	F5-CST-OPTM-DNS-PC
BIG-IP Local Traffic Manager Migration Service (per pair, standard hours)	F5-CST-MIG-BIG-LTM
Competitive Server Load Balancing Device to BIG-IP Local Traffic Manager Migration Service (per pair, standard hours)	F5-CST-MIG-COMP-LTM
BIG-IP Local Traffic Manager Automation Service with App Services iApp (per pair, standard hours)	F5-CST-PNO-LTM-AUTO
BIG-IP Application Security Manager Advanced Installation and Policy Review Service (per pair, standard hours)	F5-CST-SEC-ASM-ADV
BIG-IP Advanced Web Application Firewall LaunchPad Consulting Service (standard hours)	F5-CST-SEC-AWF-LP
LBaaS Integration Service with Red Hat OpenStack (per pair, standard hours)	F5-CST-CLD-PRV-OPST1
BIG-IP Integration with Cisco APIC (per pair, standard hours)	F5-CST-CLD-PRV-CISC1

TRAINING SERVICES

Training programs and education

F5 training helps you leverage F5 solutions to ensure your applications are secure, fast, and available in the data center and in the cloud. We offer a variety of programs to help you get the most out of your configurations. Instructor-led classes, subscription learning modules, and online, self-paced learning programs are available to customers throughout our global regions.

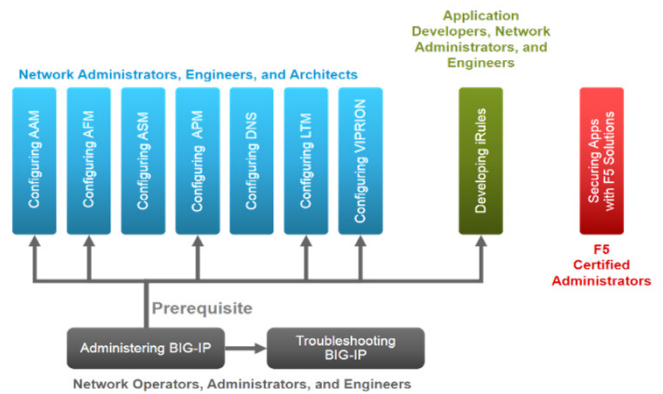

Training Services

Description	Part Number
BIG-IP Best Training Bundle (19 days)	F5-TRG-BIG-BEST
BIG-IP Better Training Bundle (12 days)	F5-TRG-BIG-BETTER
BIG-IP Good Training Bundle (7 days)	F5-TRG-BIG-GOOD
BIG-IP Local Traffic Manager Configuration Training (3 days)	F5-TRG-BIG-LTM-CFG-3
BIG-IP Administration Training (2 days)	F5-TRG-BIG-OP-ADMIN
BIG-IP Troubleshooting Training (2 days)	F5-TRG-BIG-TRBL-INT2
BIG-IP Troubleshooting Workshop (2 days)	F5-TRG-BIG-TRBL-WKS2
BIG-IP Automation Training (1 day)	F5-TRG-BIG-AUTO
BIG-IP iRule Configuration Training (3 days)	F5-TRG-BIG-IRULE-CFG
BIG-IP Security Training (2 days)	F5-TRG-BIG-SEC-2
BIG-IP Advanced Firewall Manager Configuration Training (2 days)	F5-TRG-BIG-AFM-CFG
BIG-IP Advanced Web Application Firewall Setting Up DoS Training (1 day)	F5-TRG-BIG-AWF-SU-1
BIG-IP Train-the-Trainer Instructional Techniques	F5-TRG-BIG-TTT
VIPRION Instructor Led Training (1 day)	F5-TRG-VPR-1
BIG-IP DNS Training (2 days)	F5-TRG-BIG-DNS-IL
BIG-IP Advanced Web Application Firewall Configuration Training (4 days)	F5-TRG-BIG-AWF-CFG
BIG-IP Application Security Manager Essentials Training (4 days)	F5-TRG-BIG-ASM-ESS
BIG-IP Application Security Manager Workshop (2 days)	F5-TRG-BIG-ASM-WKS2
BIG-IP Access Policy Manager Training (3 days)	F5-TRG-BIG-EGW-APM
BIG-IP Configuration Training (2 days)	F5-TRG-BIG-CFG
On-site Training - Any Combination (1 day)	F5-TRG-ONSITE-1
On-site Training - Any Combination (2 days)	F5-TRG-ONSITE-2
On-site Training - Any Combination (3 days)	F5-TRG-ONSITE-3
On-site Training - Any Combination (4 days)	F5-TRG-ONSITE-4
On-site Training - Any Combination (5 days)	F5-TRG-ONSITE-5
On-site Training - Any Combination (10 days)	F5-TRG-ONSITE-10
Online Training (5 users. 1-year subscription)	F5-SVC-TRG-SUB5-1Y
Online Training (10 users. 1-year subscription)	F5-SVC-TRG-SUB10-1Y
Online Training (5 users. 3-year subscription)	F5-SVC-TRG-SUB5-3Y
Online Training (10 users. 3-year subscription)	F5-SVC-TRG-SUB10-3Y

General disclaimer:

F5 Networks assumes no responsibility for the accuracy or completeness of the information in this product guide. F5 Networks may change the products, pricing, and specifications as well as the service offerings mentioned in this document at any time without prior notice.



©2019 F5 Networks, Inc. All rights reserved. F5, F5 Networks, and the F5 logo are trademarks of F5 Networks, Inc. in the U.S. and in certain other countries. Other F5 trademarks are identified at f5.com. Any other products, services, or company names referenced herein may be trademarks of their respective owners with no endorsement or affiliation, expressed or implied, claimed by F5.